

# CUB



Instrument User Manual V1.7



Unrivalled Detection.



Ex-Ox-Tox Gasdetectie  
Westerdreef 5V  
2152 CS Nieuw-Vennep  
Telefoon: 0252 620885  
E-mail: [info@exotox.nl](mailto:info@exotox.nl)  
Website: [www.exotox.nl](http://www.exotox.nl)

## **Register your instrument online for extended warranty**

Thank you for purchasing your Ion Science instrument.

The standard warranty of your instrument can be extended to up to five years on PhoCheck Tiger and two years on other Ion Science instruments.

To receive your extended warranty, you must register your instrument online within one month of purchase (terms and conditions apply.)

Visit [www.ionscience.com/instrument-registration](http://www.ionscience.com/instrument-registration)

## Warnings

---

<b>User Manual:</b>	Read and understand this user manual completely before operating the Cub instrument.
<b>Intrinsically Safe:</b>	<b>This Portable Cub has been designed and certified Intrinsically Safe.</b> <b>The Charger/Data Docking Station is NOT Intrinsically safe and must only be used in a safe area.</b>
<b>Static Hazards:</b>	Do not use abrasive or chemical detergents to clean the Cub instrument as this may reduce the antistatic properties of the materials used, clean it using a damp cloth only.
<b>Material Exposure</b>	The Cub must not be exposed to atmospheres known to have an adverse effect on Thermoplastic polyolefin or Anti-static PC/ABS.
<b>Servicing:</b>	The Cub and Docking Station must be serviced in a Non Hazardous environment and by Ion Science Ltd authorised service centres only.  Substitution of components may impair intrinsic safety.
<b>Battery Charging:</b>	The Cub is a rechargeable device and should only be recharged using the ISL Docking Station in a Non Hazardous environment.
<b>Charging Pins:</b>	Caution: Do not short circuit these two connections together else the internal fuse will blow and the Docking Station will need to be returned to the manufacturer for replacement.
<b>Ingress protection</b>	Continuous exposure to wet weather conditions should be limited to less than one day and harsh water spray conditions should be avoided

<b>Proper Use</b>	If the equipment is used in a manner not specified by the manufacturer, the protection provided by the equipment may be impaired.
-------------------	---

**Declaration of conformity**

**Manufacturer:** Ion Science Ltd, The Way, Fowlmere, Cambridge, UK. SG8 7UJ  
**Product:** Cub  
**Product description:** Intrinsically safe photo-ionisation gas detector for detecting volatile organic compounds  
**Directive 94/9/EC** **Required Coding -**  II 1 G Ex ia IIC T4 Ga  
 T<sub>amb.</sub> = -20°C to +55 °C  
**Certificate Number** Baseefa11ATEX0027 IECEX BAS 11.0014  
**Notified body:** Baseefa, Buxton Derbyshire, UK  
**Report number:** GB/BAS/ExTR10.0259/00  
 GB/BAS/ExTR10.0259/01  
 GB/BAS/ExTR12.0183/00  
**Notification body number:** 1180

**Notified body:** Intertek, 0359,  
 Chester, UK  
**Report number:** 11052972D1



**Intertek** 3193491 Conforms to UL Std. 913, 61010-1 & Certified to CAN/CSA Std. C22.2 No. 61010-1

**Standards**

- BS EN 60079-0: 2009** Electrical apparatus for explosive gas atmospheres. General requirements
- BS EN 60079-11: 2007** Explosive atmospheres. Equipment protection by intrinsic safety “I”
- BS EN 61326-1:2006** Electrical equipment for measurement, control and laboratory use – EMC requirements. Group 1, Class B equipment – (emissions section only)
- BS EN 61326-1:2006** Electrical equipment for measurement, control and laboratory use – EMC requirements. Industrial location immunity – (immunity section only)
- BS EN 50270:2006** Electromagnetic compatibility – Electrical apparatus for the detection and measurement of combustible gases, toxic gases or oxygen. Immunity Type 2 – industrial environments.
- BS EN 61010-1:2010** Safety requirements for measurement, control & lab equipment
- CFR 47:2008** Class A Code of Federal Regulations: 15 Subpart B- Radio Frequency Devices – Unintentional Radiators
- Other Standards**
- BS EN ISO 9001: 2008** Quality Management System – Requirements
- BS EN 13980: 2002** Potentially Explosive Atmospheres – Application of Quality Systems

On behalf of Ion Science Ltd, I declare that, on the date this product accompanied by this declaration is placed on the market, the product conforms to all technical and regulatory requirements of the above listed directives.

**Name:** Mark Stockdale

**Position:** Technical Director

**Signature:**



**Date:** 20<sup>th</sup> June 2012

## Contents

---

<b>Warnings</b> .....	<b>3</b>
<b>Declaration of conformity</b> .....	<b>4</b>
<b>Statements</b> .....	<b>6</b>
Responsibility for Use .....	6
Quality Assurance .....	6
Disposal .....	6
Calibration Facility .....	6
Legal Notice .....	6
<b>Introduction to Cub</b> .....	<b>7</b>
Getting Started .....	8
The Manual .....	8
PTFE Filter Disc .....	8
Turning On .....	8
Turning Off .....	9
Batteries .....	9
Default Settings and Calibration .....	9
<b>Using your Cub</b> .....	<b>11</b>
Turning the Cub on .....	11
Alarms .....	11
Displaying other Screens and Data .....	12
<b>CubPC software</b> .....	<b>15</b>
PC Requirements .....	15
Installation of CubPC Software .....	15
Connecting a USB or Calibration Docking Station to a PC .....	15
Starting CubPC .....	18
Upgrading Firmware and Software .....	20
The Help Page .....	20
Getting Help .....	21
Setting Docking Station Preferences .....	22
The Dock Page .....	23
Configuring a Cub .....	24
Downloading Data Logged Readings .....	26
Viewing Logged Data .....	26
Saving Logged Data to a CSV File .....	27
Viewing Details of Logged Data .....	28
Deleting all Logged Data .....	30
Software Disclaimers .....	31
<b>Battery charging</b> .....	<b>32</b>
Recharging Battery .....	32
Charging Pins .....	32
<b>Diagnostics</b> .....	<b>33</b>
<b>Maintenance</b> .....	<b>34</b>
Calibration .....	34
Bump Test .....	35
Ingress of Water .....	35
PTFE Filter Disc (871026) .....	35
Lamp Cleaning .....	37
<b>Cub parts</b> .....	<b>38</b>
<b>Accessories</b> .....	<b>39</b>
<b>Instrument warranty and service</b> .....	<b>40</b>
Warranty .....	40
Service .....	40
Contact details .....	40
<b>Technical specifications</b> .....	<b>41</b>
<b>Manual log</b> .....	<b>42</b>

## Statements

---

### Responsibility for Use

The Cub detects a pre-selected range of gases which are potentially dangerous from both a poisoning and/or an explosive perspective. The Cub has adjustable and selectable features allowing the detector to be used in a pre-selected way. Ion Science Ltd can accept no responsibility for the incorrect adjustment of features that cause harm or damage to persons or property. The Cub is a personal safety device, it is the user's responsibility to respond appropriately to an alarm situation.

Inadequate performance of the gas detection equipment described in this manual may not necessarily be self-evident and consequently equipment must be regularly inspected and maintained. Ion Science Ltd recommends that personnel responsible for equipment use a regime of regular checks to ensure it performs within calibration limits, and that a record be maintained which logs calibration check data. The equipment should be used in accordance with this manual, and in compliance with local safety standards.

### Important

It is essential that the Cub is always used with a supplied 0.5 micron PTFE Filter Disc fitted to the front of the instrument. Without a filter, particles of debris and dust can be drawn into the detector inhibiting the function of the instrument. These filters are consumable and should be changed after every 100 hours of use. The frequency of replacement should be increased for dusty or moisture laden environments. Filters are available from your distributor or at [www.ionscience.com](http://www.ionscience.com)

### Quality Assurance

The Cub has been manufactured in compliance with the latest edition of ISO9001, which ensures that the equipment supplied to our customers has been designed and assembled reproducibly, from traceable components, and leaves Ion Science Ltd calibrated to stated standards.

### Disposal

Dispose of the Cub, Docking Station and it's components in accordance with all local and national safety and environmental requirements. This includes the European WEEE (Waste Electrical and Electronic Equipment) directive. Ion Science Ltd offers a take back service. Please contact us for more information.

### Calibration Facility

Ion Science Ltd offers a calibration service including the issue of certification confirming calibration with equipment traceable to national standards. A Cub calibration kit is available from your distributor or service centre or at [www.ionscience.com](http://www.ionscience.com) Ion Science Ltd recommends annual return of all instruments for yearly service and calibration.

### Legal Notice

Whilst every attempt is made to ensure the accuracy of the information contained in this manual, Ion Science Ltd accepts no liability for errors or omissions, or any consequences deriving from the use of information contained herein. It is provided "as is" and without any representation, term, condition or warranty of any kind, either express or implied. To the extent permitted by law, Ion Science Ltd shall not be liable to any person or entity for any loss or damage which may arise from the use of this manual. We reserve the right at any time and without any notice to remove, amend or vary any of the content which appears herein.

## **Introduction to Cub**

---

The Cub is a personal portable gas detector that detects a pre-selected range of Volatile Organic Compounds (VOC's) which can be dangerous from both a poisoning and explosive perspective. The Cub uses a Photoionisation Detector (PID) to measure gas concentrations. The patented Fence Electrode Technology minimises the effects of moisture and contamination, avoiding the need for humidity compensation.

The Cub is used to check for conformity of Short Term Exposure Limits (STELs) and Time Weighted Averages (TWAs) that are specific for particular hazardous environments (for example EH40 in the UK and OSHA in the USA). In this mode of operation STELs and TWAs are continually calculated and compared to levels set in the instrument.

Alarm conditions can be indicated by a programmable combination of an audible alarm, vibration and bright flashing LEDs. Red and Orange LED's indicate High and Low conditions respectively.

The Cub can be used with three types of Cub Docking Stations, these docking stations are for indoor use only, are not Intrinsically Safe so must only be used in a safe area.

### Cub Recharging Docking Station

- simply used to recharge a Cub's battery
- equipped with LED to clearly indicate power

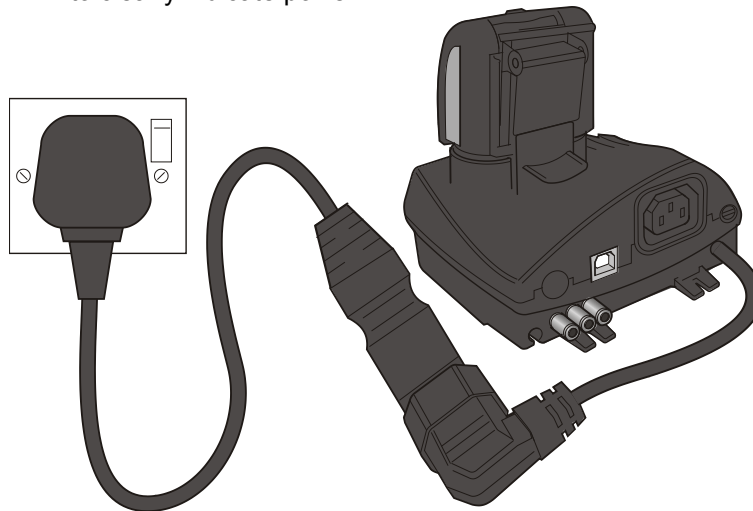

### Cub Recharging and USB Docking Station

- used to recharge a Cub's battery
- connects via a standard USB cable in order to transfer logged readings from a Cub to that PC
- equipped with LED's to clearly indicate power and USB connection

### Cub Recharging and Calibration Docking Station

- can be used to perform the functions of both the above docking stations, and also to calibrate a Cub using CubPC
- equipped with LED's to clearly indicate power, USB and calibration conditions

The source of power for the docking station is either:-

1. Through the IEC mains plug limited to a nominal of 100Vac to 240Vac +/-10% input range. The inlet fuse is Mains ceramic 1A time lag (anti-surge 20 x 5mm cartridge).
2. Through the rear DC Skt connected to a 12V car auxiliary/ (cigarette lighter) outlet.

**Introduction to Cub**

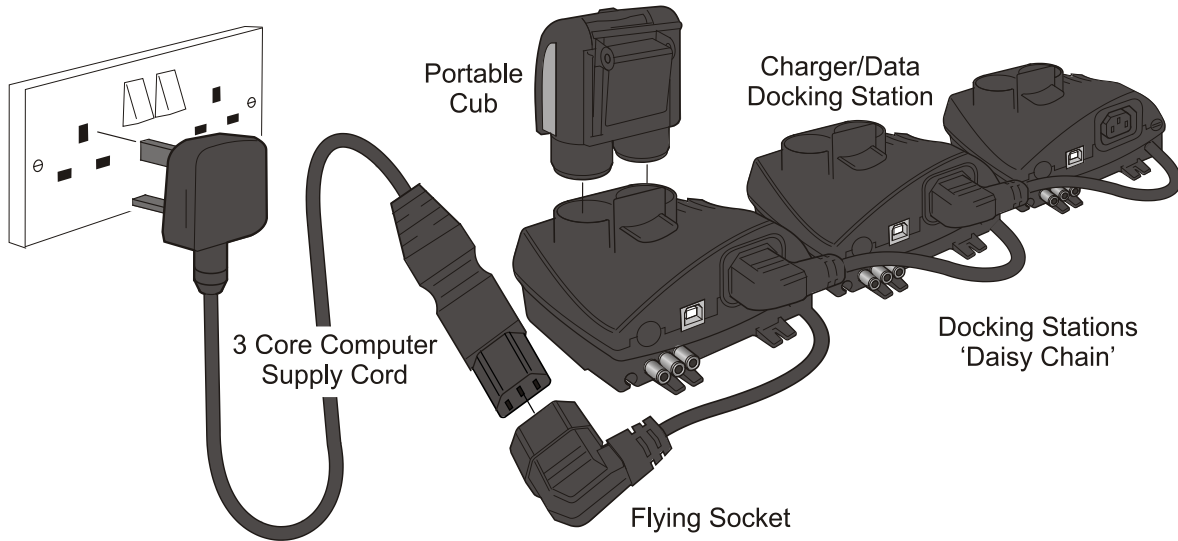

The docking station is connected to the mains supply using a universal IEC mains lead plugged into the flying socket part of the docking station. Multiple docking stations can have their flying leads connected as shown above and only require one universal computer supply cord for all docks connected together. CubPC is a software program that enables users to calibrate a Cub (via a Cub Calibration Docking Station) from their own PC. CubPC also helps manage logged data files and multiple instrument settings in a clear and concise way.

**Getting Started**

Thank you for choosing the Cub from Ion Science Ltd. We hope that your Cub will give you many years of active and trouble-free service.

**The Manual**

Ion Science Ltd recommend that you familiarise yourself with this manual before using your Cub. The 'Statements' and 'Introduction to the Cub' sections contain important information, which should be read before you turn your Cub on for the first time.

**PTFE Filter Disc**

For the quoted IP65 rating the PTFE Filter Disc and O'Rings must be fitted in both caps to stop dust and water from entering into the instrument. For full stated performance the PTFE Filters only need be changed if blocked by dust or water. Details on how to change and fit a filter (as required) are detailed in the 'Maintenance' section.

**Turning On**

Press and hold the button on the top of your Cub for three seconds to turn it on. The Cub will beep when the button is first pressed. A progress bar is shown on the display screen as the unit switches on, with segments being added to it from left to right.

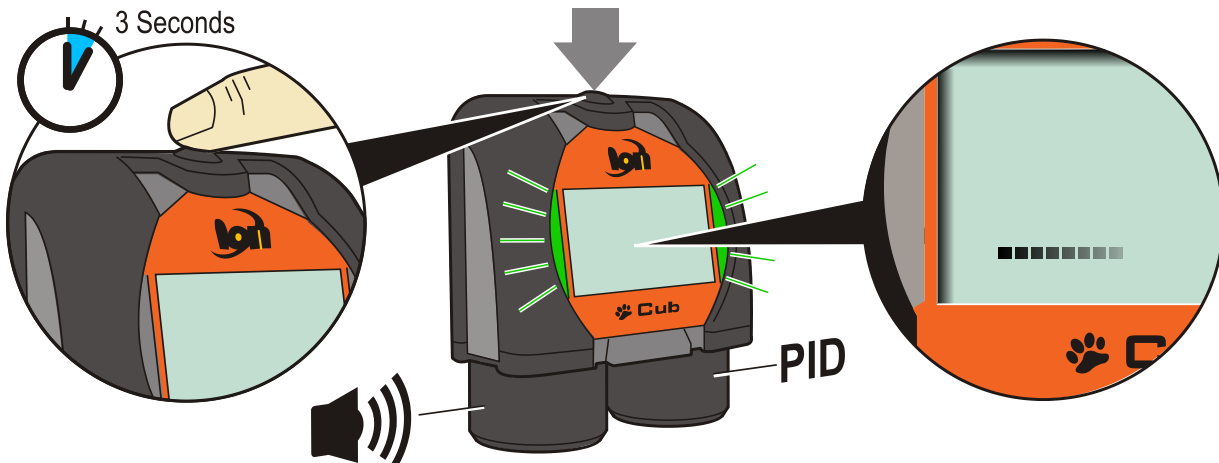



## **Introduction to Cub**

---

### **Turning Off**

Press and hold the button on the top of your Cub for three seconds to turn it off.

A progress bar is shown on the display screen as the unit switches off, with segments being removed from the bar from right to left.

### **Batteries**

Fully charge the Cub before use.

The rechargeable 3.7V Li-Ion battery in your Cub cannot be replaced, but should last for the lifetime of the instrument.

### **CAUTION:**

**Li-Ion Batteries can be damaged if left in a discharged state. Please recharge Cub if battery indicator is showing empty. Please note also that if Cub is left for one year unused, the instrument needs to be charged fully before it can continue to be kept in storage. Please repeat annually.**

### **Recharging the Battery**

Cub instruments leave the factory with the battery fully charged. However prolonged periods of storage may result in the battery discharging. We recommend charging the instrument for at least four hours before use. See the 'Recharging' section of this manual.

### **Default Settings and Calibration**

Cub instruments leave Ion Science Ltd pre-set for gas type Isobutylene. Instruments are factory calibrated against isobutylene and all response factors are equivalent to this.

### **CubPC**

The gas type and associated calibration can be changed using the CubPC software and a Cub Calibration Docking Station. Ion Science Ltd recommends that you load the software supplied with your instrument and set up your Cub according to the instructions in the 'CubPC Software' section of this manual.

## Introduction to the display screen

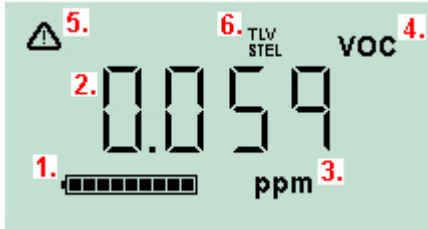

1. Battery charge indicator
2. Detected gas level
3. Gas level units (ppm or mg/cm<sup>3</sup>, depending on how the Cub is configured)
4. "Volatile Organic Compound" This indicates the gas sensor type selected
5. This symbol appears when a STEL or TWA alarm is exceeded
6. If the "TLV" (Threshold Limit Value) and "STEL" (Short Term Exposure Limit)" icon is present, on-going calculated values are being displayed

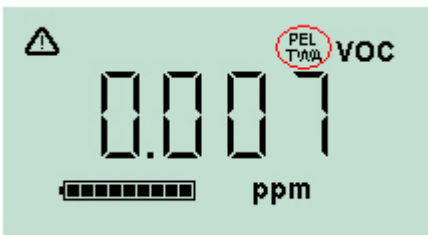

If the "PEL (Permissible Exposure Limit) and TWA (Time-Weighted Average) icon is present, the on-going calculated value is being displayed.

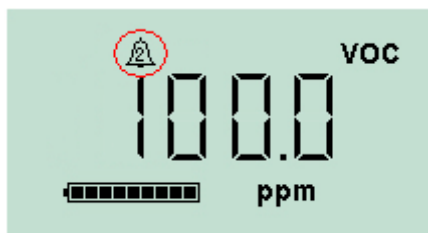

The symbol highlighted indicates that a high level alarm has been triggered.

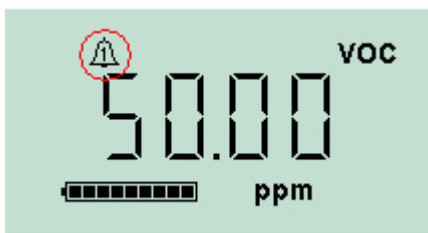

The symbol highlighted indicates that a low level alarm has been triggered.

## Using your Cub

---

### Turning the Cub on

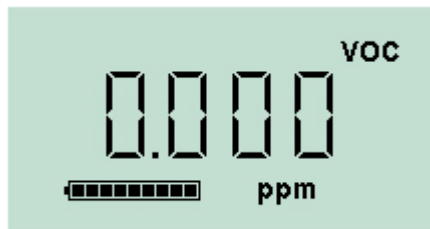

Press and hold the button on the top of your Cub for three seconds to turn it on. The Cub will beep when the button is first pressed. A progress bar is shown on the display screen as the unit switches on, with segments being added from left to right. When the Cub is switched on, the display screen will be illuminated with a green light for a few seconds, and the firmware version number is displayed. The screen will display the detected gas level and the current battery charge condition.

### Alarms

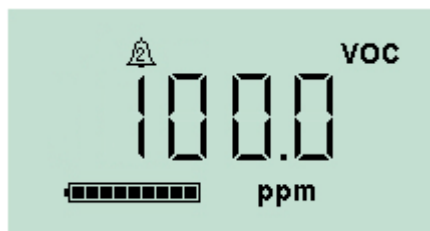

If the detected gas level triggers a high level alarm, the display screen will be illuminated with a flashing red light, and the lights on the top of the unit will flash red.

The high level alarm symbol will be displayed on the screen.

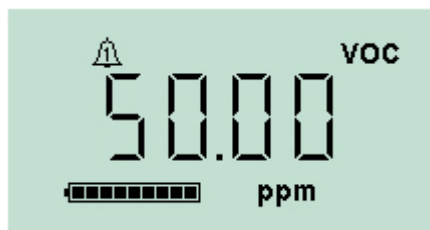

If the detected gas level triggers a low level alarm, the display screen will be illuminated with a flashing orange light, and the lights on the top of the unit will flash red.

The low level alarm symbol will be displayed on the screen.

Depending on how the Cub was set up (see Configuring a Cub, below), an alarm may also sound and the unit may vibrate.

If the alarm latch is set (see Configuring a Cub, below), these alarm indications cannot be switched off except by switching off the Cub, or placing it in a docking station.

If the alarm latch is not set, pressing the button once will turn off the alarm sound and vibration. The alarm lights will continue to flash.

Pressing the button a second time will stop the alarm lights flashing, however, they will continue to flash if the gas level is above the alarm threshold.

## Using your Cub

### Displaying other Screens and Data

Cycle through the different Cub data screens by pressing the button. When a new screen is accessed the display is illuminated with a coloured light which will turn off after a few moments.

When the display is lit up, a different screen is displayed every time the button is pressed (except when an alarm has been triggered – see above). If the display is not lit up, the button must be pressed again to light it up before the screens can be cycled through.

The screens you can view are listed below in the order that they are accessed.

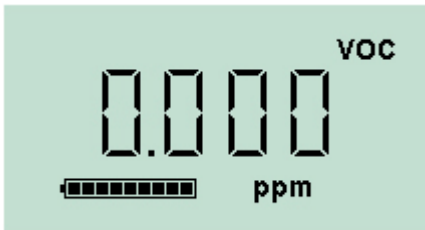

The gas level indicator screen. This is the screen which is displayed by default when a Cub is turned on. The screen lights up green when it is accessed.

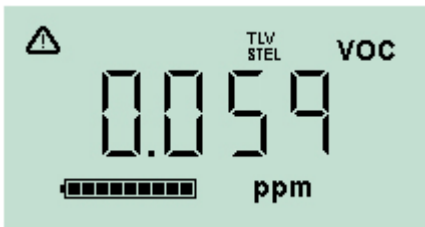

This screen shows the on-going live TLV / STEL calculation and the backlight illuminates light blue for around 10 seconds.

If an alarm state is triggered the user should withdraw from the hazardous environment and act in accordance with national safety regulations.

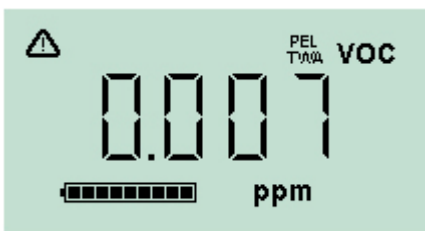

This screen shows the on-going live PEL / TWA calculation and the backlight illuminates dark blue for around 10 seconds.

If an alarm state is triggered the user should withdraw from the hazardous environment and act in accordance with national safety regulations.



This screen displays the current time. The screen lights up green when it is accessed.

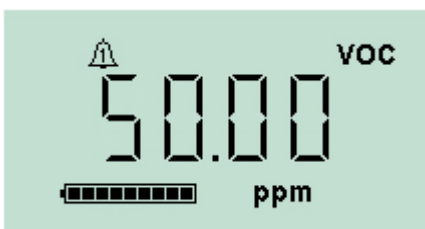

This screen indicates the low alarm level set for the Cub. The screen lights up orange when it is accessed.

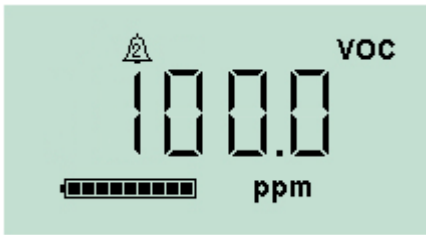

This screen indicates the high alarm level set for the Cub. The screen lights up red when it is accessed.

**Using your Cub**

---

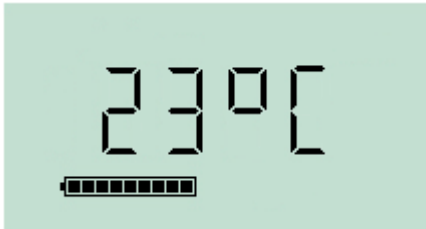

This screen displays the current temperature. The screen lights up green when it is accessed.

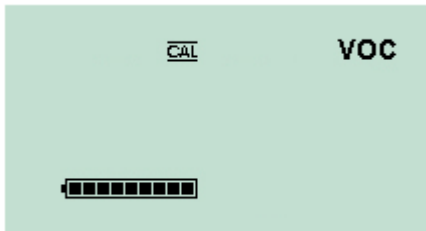

This is the remote calibration screen, it is via this screen the custom calibration routine is accessed. This allows the Cub to be calibrated in the field using a portable gas supply. Please note: To carry out a remote calibration the Span gas type and concentration must be setup on the configuration screen within CubPC and sent to the Cub instrument.

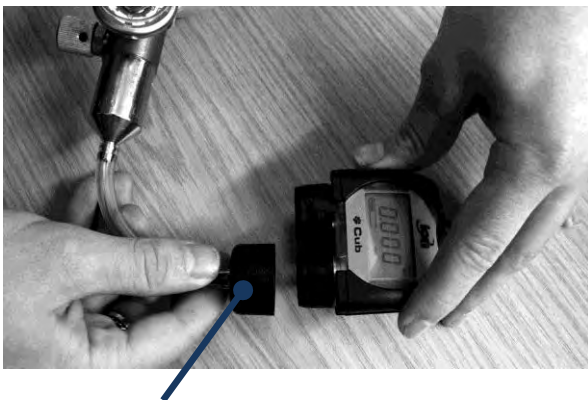

Remote calibration adaptor

The following equipment is required.

- A clean ambient air supply or a bottle of compressed synthetic air fitted with a 0.3Liter per minute flow regulator
- A bottle of compressed Span gas fitted with a 0.3Litre per minute flow regulator
- Remote calibration adaptor
- Suitable pipe to connect gases to the remote calibration adaptor

**IMPORTANT:** The use of Silicon pipe should be avoided as VOC gases permeate in to the walls of the tube.

**Remote Calibration Procedure**

While on the remote calibration screen press and hold the on/off button until the Cub gives an audible beep then release it quickly to avoid switch off.

The screen will change and display a '0'. At this point connect a clean ambient air supply or a bottle of compressed synthetic air. Switch on the gas supply and then press the on/off button.

The screen will change and display a live reading from the sensor. **IMPORTANT:** This number does not relate to gas concentration, it simply indicates if the sensor output is moving. The output should go lower,

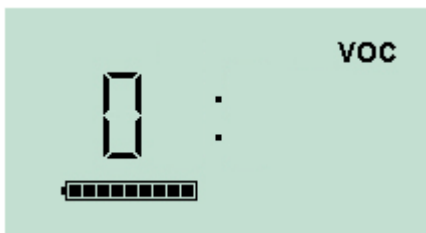

once the number stops moving. Press the on/off button to accept the level. The screen will briefly flash to acknowledge the entry.

Switch off the synthetic/clean air and disconnect the clean air supply.

## Using your Cub

---



Press the on/off button to initiate the Span stage. The screen will change and display an 'S'. At this point connect the Span gas supply. Switch on the gas supply and then press the on/off button.



The screen will change and display a live reading from the sensor. **IMPORTANT:** This number does not relate to gas concentration, it simply indicates if the sensor output is moving. The output should increase, once the number stops moving press the on/off button to accept the level. The screen will briefly flash to acknowledge the entry. Switch off the synthetic/clean air and disconnect.

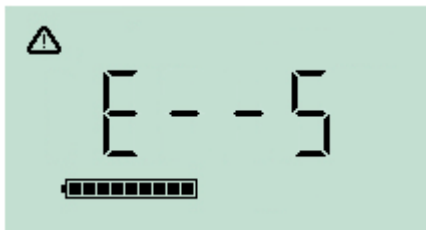

If there is not a significant difference between the Zero and Span levels the calibration will be invalid and E- - 5 will be displayed. If this occurs the previous valid calibration levels will be used.

At the end of the calibration sequence the Cub will revert to the general VOC / normal running.

**IMPORTANT:** Always check the calibration in normal running before use. Apply the same Zero and SPAN gas used to calibrate and ensure the correct readings are displayed.

## CubPC software

---

### PC Requirements

CubPC Software must be used in conjunction with a PC or laptop using Windows XP, Windows Vista or Windows 7. The host computer must have a .net framework installed to level 3.5 service pack 1 or above before installing CubPC. Please see the following link:

<http://www.microsoft.com/en-us/download/details.aspx?id=25150>

Software is downloaded from the Ion Science website from:-

[www.ionscience.com/product-support/downloads/instrument-software](http://www.ionscience.com/product-support/downloads/instrument-software)

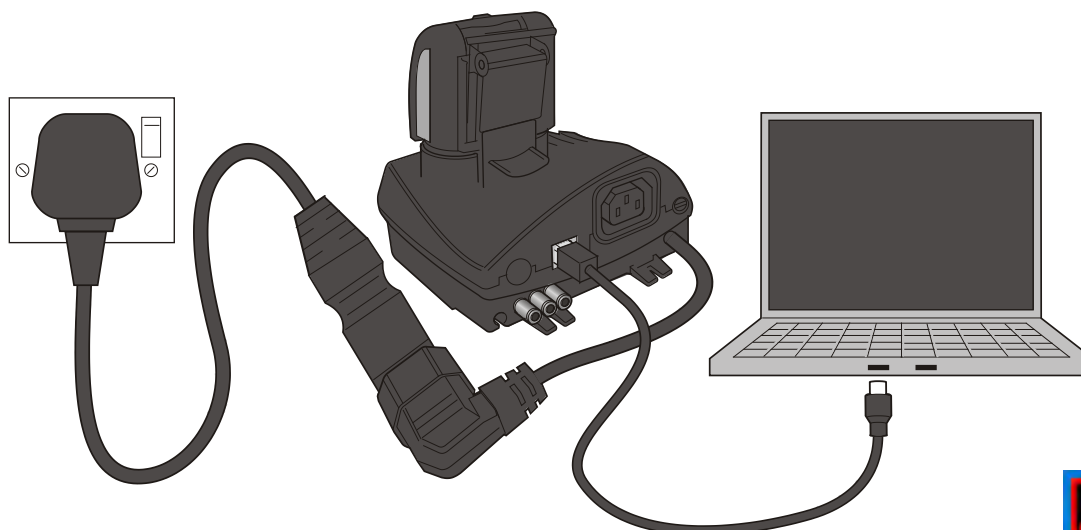

### Installation of CubPC Software

The CubPC software is downloaded from the Cub webpage (<http://www.ionscience.com/product-support/downloads/instrument-software>) in a zip file. Extract all the files from the zip file and click on the setup .exe file (which will be indicated with the Cub icon). The installation wizard will then start. Follow the onscreen instructions to complete the installation. If you selected this option during the installation procedure, the Cub icon should appear on your desktop.

### Connecting a USB or Calibration Docking Station to a PC

With the docking station powered on (the Charge LED should be green), simply connect it using the provided USB cable to a USB socket on your PC.

The USB LED light will be red when there is no USB connection. Once a connection is made, the USB LED light will then change to yellow while the docking station and the PC communicate – e.g. while any logged data from a connected Cub is transferred to the PC. When this is complete, the USB LED will change to green.

Multiple docking stations can be connected to a PC via a USB hub. When a docking station is first connected to a PC on which the CubPC software has been installed, the installation of the device driver software will be triggered.

If your PC is running Windows 7 or Vista, this will take place automatically:

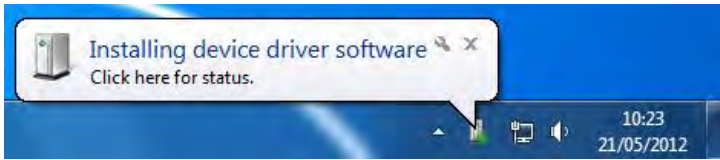



## CubPC software

---

If it is running XP, the Found New Hardware Wizard is started:



Click any of the above options as required and then click 'Next'.

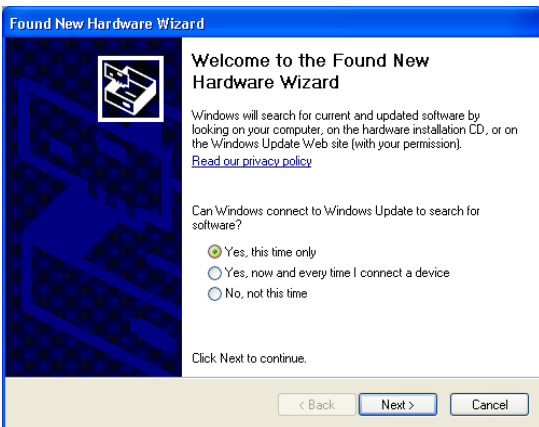

Click 'Install the software automatically'.

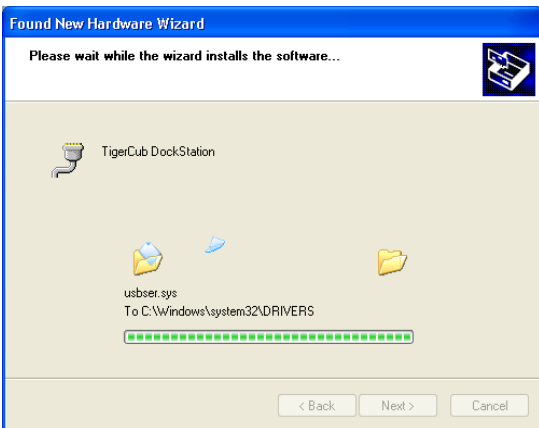

The wizard then installs the software.



Click 'Finish' to close the wizard.

## CubPC software

### Starting CubPC



Double click the Cub icon on your desktop and open CubPC. The Cub splash screen will then be briefly displayed:

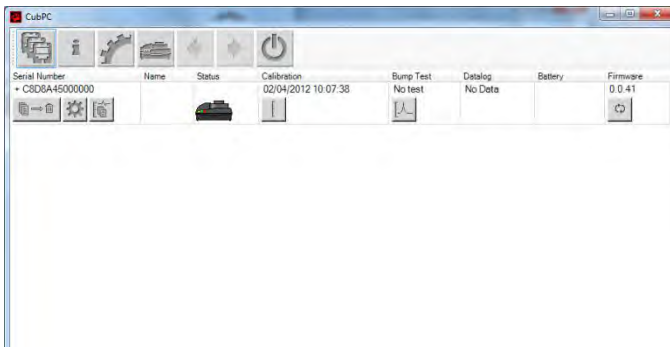

CubPC then opens.

The Cub's page is initially displayed. It lists the currently and previously connected docking stations.

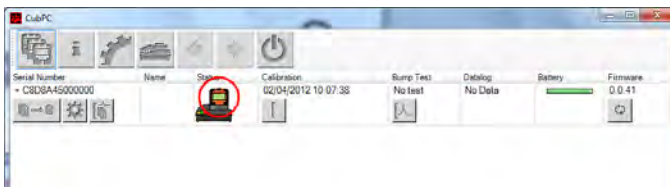

If a Cub is connected to a CubDoc docking station, this is indicated by the picture under the 'Status' heading. For example:

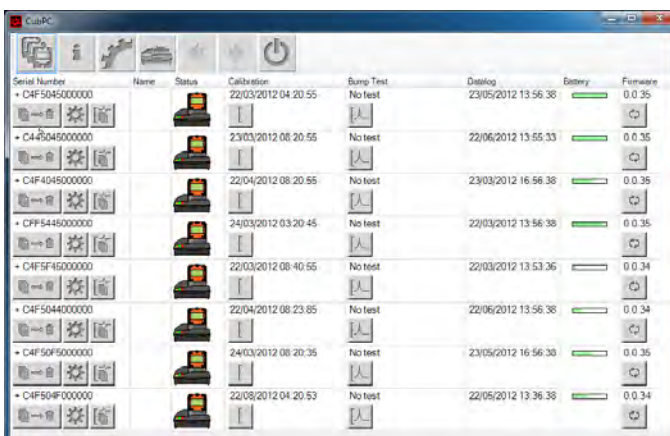

If multiple docking stations are connected, they will each be listed. For example:

**Note:** Where there are multiple docking stations connected, it may not be obvious on the Cub's page which is which. In order to identify which unit is which, click in one of the 'Status' fields. The Charge and Diagnostic LEDs on the docking station in question will both flash purple for a few seconds.

## CubPC software

For each connected Cub, the following are displayed:

- The Cub serial number
- The Cub name (if one has been assigned using the configuration page)
- The time and date that the Cub was last calibrated
- The time and date of the last bump test
- The time and date of the most recent data log received from the Cub
- The current battery charge of the Cub
- The current firmware version installed on the Cub

The Cub's page also includes, for each Cub, buttons to delete logged data, save logged data to CSV files, open the Cub configuration page, view logged data, calibrate the Cub, perform bump tests and update the Cub firmware.

The large buttons at the top of the screen provide the following facilities:



Opens the Cub's page, as described above.



Opens the Help page, which displays general information on the CubPC software and provides access to technical support and documentation.



Opens the Preferences page, used to specify the actions taken when a Cub is connected to a dock and history and calibration preferences.



Used to view details of the connected docks and perform purges and firmware updates.



Used to browse back and forward through the CubPC pages you have viewed.



Used to close CubPC.

Additional data and facilities for a Cub can be accessed by clicking the + symbol next to the serial number of that Cub. The additional details are then displayed:

IRN	Name	Status	Calibration	Bump Test	Datalog	Battery	Firmware
- C839D45000000	Number 2		30/05/2012 16:29:45 Zero: 2732,1165 Span (50): 44085,2751	No test 	25/07/2012 14:45:13 → CSV 25/07/2012 14:45:13 Min 0.000 Max 0.091 STEL 0.000		0.0.50 

## CubPC software

---

The Calibration column displays the zero and span levels that the Cub is calibrated to.

The Data log column displays the minimum and maximum levels of gas, and the detected STEL and TWA levels recorded in the last data log.

The column also displays an additional button for viewing details of the last data log (see Viewing Details of Logged Data).

### Upgrading Firmware and Software

Before you do anything else you may wish to check whether any upgrades are available for either the Cub, the docking station, or the software.

Software updates are installed using the Help page (see below).

To update the Cub firmware, click this button on the Cub page, under the firmware heading: .

Note that upgrading the firmware of a Cub will result in any logged data on that Cub being automatically deleted.

To update the docking station firmware, click the same button on the Dock page.

If the firmware is up to date, nothing will happen.

If a newer version is available, it will then be downloaded and installed on the equipment (an internet connection is required). A progress indicator will be displayed in the Firmware field while the upgrade is in progress.

The new firmware version will then be displayed in the field.

### The Help Page

Click this button to open the Help page: .

**CubPC**  
Version 0.0.0.11  
Copyright Ion Science Ltd 2012  
Registered to: Invalid licence file

[Contact Technical Support](#)

Feature Name	Status	Valid Until

  
View Manual

  
Web Support

  
Adobe Web Site

A new version is available  
0.0.0.13

[View Release Notes](#)  
[Install Upgrade](#)  
[Poll Website now](#)

## CubPC software

---

The current software version is displayed at the top of the page, along with copyright information, who is it licensed to, etc.

### Getting Help

The 'View Manual' button opens this manual. If you can't find the help you need in this manual, you can get help in two further ways.

If you want to send a question to Technical Support, click 'Contact Technical Support'. The following page is then displayed:

The screenshot shows a contact form with the following fields and buttons:

- Your email address (to allow us to reply)**: A text input field.
- Instrument number**: A dropdown menu.
- Additional Files to send**: A large empty rectangular area for file uploads.
- Subject**: A text input field.
- Please describe in as much detail as possible the nature of issue:**: A large text area for the message content.
- Buttons**: 'Clear Form', 'Add File ...', 'Remove File', 'Cancel', and 'Send'.
- Confirmation**: A checkbox with the text 'I confirm that I am sending data to Ion Science Ltd and am happy for Ion Science Ltd to use that data'.

Complete the form, making sure you enter your email address and the instrument number, and click 'Send'.

You can attach a file to your message via the 'Add File...' button.

If you wish to access our support web page, click 'Web Support'. The page will then be displayed. It lists our network of authorised service centres and describes the services they offer.

### Upgrading the Software

If a newer version of the software is available, this is stated in the lower-left section of the page.

To install the newest version, click 'Install Upgrade'.

The install will then take place. The old version of the software will automatically shut down and be replaced by the new version, which will then start up automatically.

## CubPC software

### Other Facilities

The Adobe Website button opens the Adobe Reader download page. It is recommended that this manual is viewed using Adobe Reader.

To view the release notes for the software, click 'View Release Notes'. A new window is then displayed in which the release notes can be viewed.

For example:



To check to see if an upgrade is available, click the 'Poll Website' button. If no upgrade is available nothing will happen. If an upgrade is available, details of the new version will appear in the text area to the left of the button.

### Setting Docking Station Preferences



Click this button to open the Preferences page:

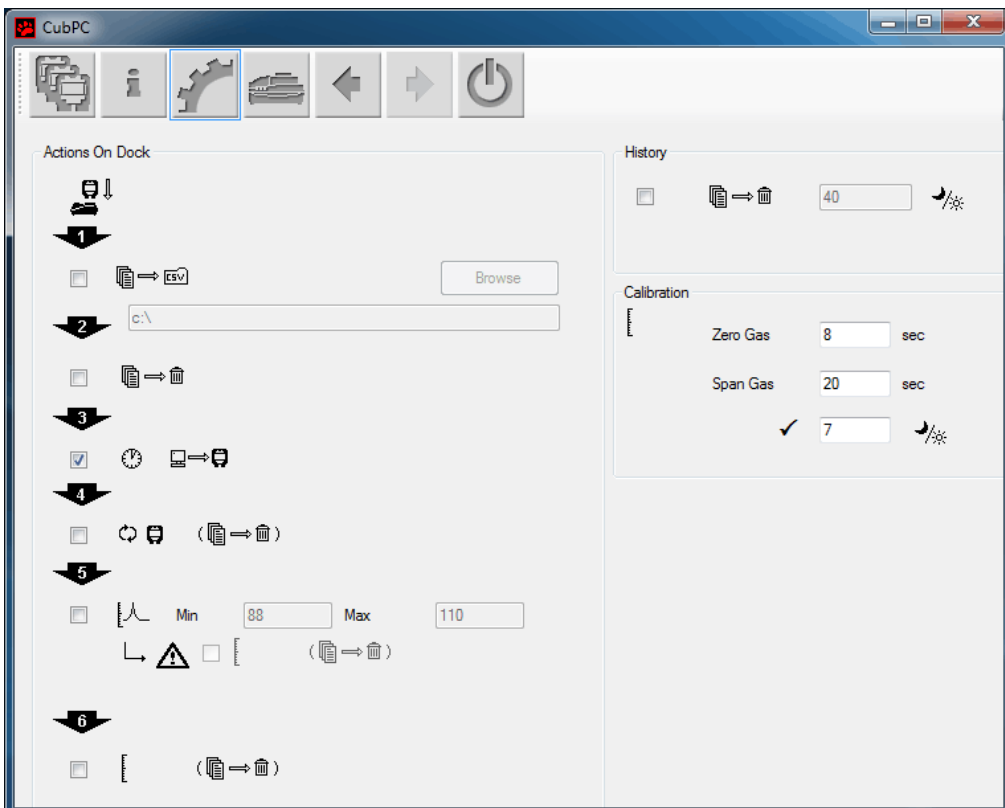

## CubPC software

When you place a Cub in a CubDoc docking station, logged data is automatically copied to the connected PC. Use this page to control what else happens automatically when you place a Cub in a docking station, and to specify history and calibration settings.

### Actions On Dock

6. If when a Cub is placed in a calibration docking station and logged data is to be automatically written to a .CSV file on the connected PC, tick the first checkbox. Use the 'Browse' button to specify the folder to which .csv files are to be written.  
Note that this is in addition to the automatic copying of logged data to the PC mentioned above. Such data may be viewed using CubPC, but it is encoded and may not be edited. Data transferred to CSV files may be freely edited, using Microsoft Excel for example.
2. If logged data is to be deleted from a Cub, click the second checkbox. If the first checkbox is also checked, this will happen after it is written to a .csv file.
3. If the time and date on the Cub is to be automatically synchronised with that on the PC to which the docking station is connected, tick the third checkbox.
4. If firmware on a Cub is to be automatically upgraded when placed in a docking station (if a newer version is available), click the fourth checkbox.  
Note that this will result in any logged data on the Cub being automatically deleted.
5. If the Cub is to be automatically bump tested when placed in a docking station, click the fifth checkbox. See page 35 for details of how to perform a bump test.  
If the bump test detects that the readings are outside the set minimum or maximum sensitivity limits (see Configuring a Cub), and the second checkbox in this step is checked (the one next to this symbol: ) , the instrument is automatically recalibrated.
7. If all data is to be deleted from a Cub when it is placed in a docking station, click the sixth checkbox. Note that all data on a Cub is automatically downloaded and stored on the connected PC when it is docked.

### History

If logged data more than a certain number of days old is to be deleted from the PC, tick the checkbox in the 'History' section of the page and enter the number of days in the field next to it.

### Calibration

In the Calibration section, enter for zero gas and span gas the number of seconds that zero and span gas is to be sent to a connected Cub when it is being calibrated.

It is recommended that a bump test be performed after changing these settings.

### The Dock Page



Click this button to open the Dock page:

Use this page to view details of the connected docks and perform purges and firmware updates on docks.

Dock	Status	Firmware	Purge
+ D21C292462B002C00		0.0.10 	Purge <input type="button" value="G1 Purge"/> <input type="button" value="G2 Purge"/> <input type="button" value="G3 Purge"/>

The page lists all connected docking stations.

The Dock field displays the serial number of each dock.

The Status field indicates whether or not a Cub is attached to a dock, as explained above (see Starting CubPC).

## CubPC software

The Firmware field displays the current version of the firmware installed on the dock, and contains a button to upgrade it to the newest version (see Upgrading Firmware and Software). Buttons displayed in the Purge field are for diagnostic use only.

### Configuring a Cub

To configure a Cub, click the  button on the Cub's page for that Cub. The following page is displayed:

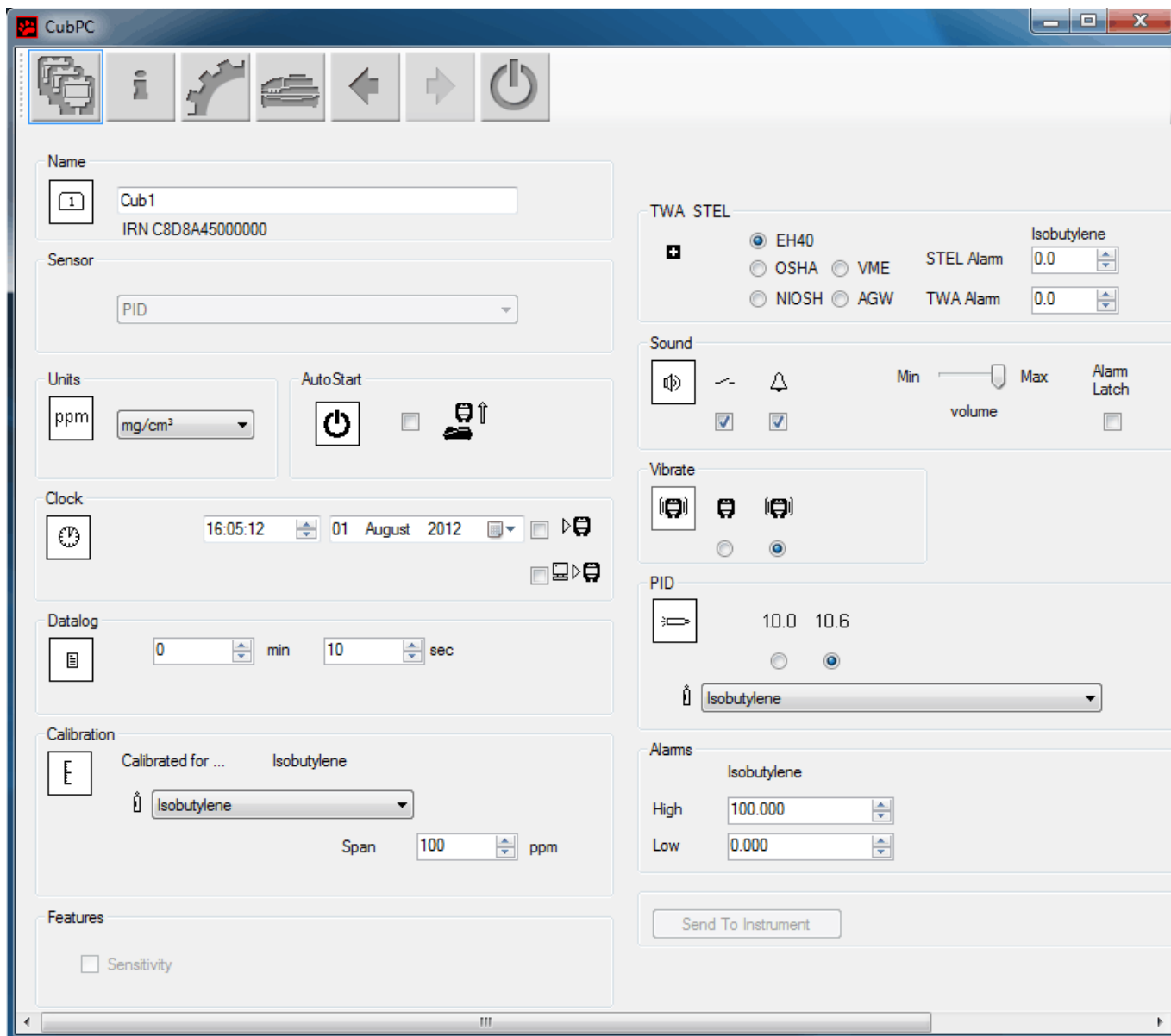

The screenshot shows the CubPC software interface with the following configuration options:

- Name:** Cub1, IRN C8D8A45000000
- Sensor:** PID
- Units:** ppm, mg/cm<sup>3</sup>
- Auto Start:**  (power icon),  (cub icon)
- Clock:** 16:05:12, 01 August 2012
- Datalog:** 0 min, 10 sec
- Calibration:** Calibrated for ... Isobutylene, Isobutylene, Span 100 ppm
- Features:**  Sensitivity
- TWA STEL:**
  - EH40,  OSHA,  VME,  NIOSH,  AGW
  - STEL Alarm: Isobutylene 0.0
  - TWA Alarm: Isobutylene 0.0
- Sound:**  (speaker icon),  (bell icon), volume slider (Min to Max),  Alarm Latch
- Vibrate:**  (cub icon),  (cub icon),  (cub icon)
- PID:** 10.0, 10.6, Isobutylene
- Alarms:** Isobutylene, High 100.000, Low 0.000
- Send To Instrument:** [button]

#### Name

If required, enter a name for the Cub in this field.

#### Sensor

Displays the sensor type.

#### Units

The units of measurement may be chosen as parts per million (ppm) or milligrams per cubic metre (mg/m<sup>3</sup>).

#### Clock

Set the time and date and tick the checkbox to the right of these fields to set the time on your Cub. Alternatively, tick the lower box to synchronise your Cub with the time on your computer.



## CubPC software

---

### Data log

Use this area to set the interval between readings. The minimum time permitted is one second.

### Calibration

From the drop-down list, select the gas that the Cub is calibrated for.

Cub offers two-point calibration (zero to a specified concentration). To define the span that the Cub is calibrated for, in the 'Span' field, enter the concentration in ppm.

The calibration procedure is detailed in the 'Maintenance' section of this manual.

### Features

Low sensitivity Cubs can be upgraded automatically via an internet connection. The customer can purchase an upgrade from his local distributor or supplier. Once the upgrade has been purchased the instrument must be connected to a computer running the CubPC software. The Cub instrument will then be automatically upgraded, via the internet connection.

### TWA STEL

Select the appropriate regulatory code to which you are working using the radio buttons.

In the 'TWA Alarm' and 'STEL Alarm' fields, enter more different (i.e. more stringent) TWA and STEL alarm levels if required.

### Sound

If there is to be a sound when the button on the Cub is pressed, tick the first checkbox.

If there is to be a sound when there is an alarm on the Cub, tick the first checkbox.

Sound volume is adjusted with the slider.

Tick the 'Alarm Latch' checkbox if an alarm is to continue to sound after the conditions that triggered the alarm are no longer present.

Note: Unchecking this box means the alarm can be reset by pressing the on/off button twice. The first press silences the audio alarm, the second press stops the LED's flashing.

### Vibrate

If, when there is an alarm, the Cub is to vibrate, select the second radio button. If not, select the first.

### PID

Select the PID lamp type from the two options. Ensure that the lamp selected is the same as that fitted in your Cub.

### Alarms

In this section enter the high and low alarm levels for the selected gas.

### Screens

In this section tick and un-tick the checkboxes to specify which screens are displayed in the Cub. Refer to 'Understanding the Display Screen' for further details.

### Send to Instrument

When you have entered the required configuration, send it to your Cub by pressing the 'Send to Instrument' button.

The USB LED on the docking station will change to yellow while the new settings are being downloaded to the connected Cub.

If the message 'There was a problem sending to the instrument' appears, click OK. Repeat the procedure under 'Starting CubPC' above and repeat the procedure. If your PC still fails to write to your Cub seek advice from your distributor or from Ion Science Ltd.

## CubPC software

### Downloading Data Logged Readings

Connect your Cub to your PC as described previously. Any fresh data-logged readings will be automatically downloaded as the software 'reads' your Cub. While this is happening, the PC LED on the docking station will change to yellow.

### Viewing Logged Data



To view logged data, click the  button on the Cubs page for that Cub. The following page is displayed:

C839D4500000	Name	Calibration	Bump Test	Datalog	Firmware
+ 13/06/2012 10:27:17	Number 2	30/05/2012 16:29:45	No test	No Data	0.0.42
+ 13/06/2012 10:28:00	Number 2	30/05/2012 16:29:45	No test	13/06/2012 10:27:30 	0.0.42
+ 13/06/2012 10:30:35	Number 2	30/05/2012 16:29:45	No test	No Data	0.0.42
+ 13/06/2012 10:38:30	Number 2	30/05/2012 16:29:45	No test	13/06/2012 10:31:24 	0.0.42
+ 13/06/2012 10:41:59	Number 2	30/05/2012 16:29:45	No test	13/06/2012 10:39:06 	0.0.42
+ 13/06/2012 10:43:25	Number 2	30/05/2012 16:29:45	No test	No Data	0.0.42
+ 13/06/2012 10:47:18	Number 2	30/05/2012 16:29:45	No test	13/06/2012 10:44:08 	0.0.42
+ 13/06/2012 10:47:41	Number 2	30/05/2012 16:29:45	No test	No Data	0.0.42
+ 13/06/2012 10:52:59	Number 2	30/05/2012 16:29:45	No test	13/06/2012 10:48:00 	0.0.42
+ 13/06/2012 10:59:26	Number 2	30/05/2012 16:29:45	No test	13/06/2012 10:55:33 	0.0.42

The page lists each time that the Cub was connected to the docking station.

The time and date of each connection is recorded, along with the name and firmware version of the Cub at that time, the time and date of the calibration that the Cub was operating under at the time, and the time and date of the last bump test of the Cub made before the connection.



The Data log column displays the time and date of the start of each data log (i.e. when the Cub was switched on and started detecting and recording gas levels).

The column also displays a button for saving logged data to a CSV file (see below).

To view additional calibration and data log details associated with a connection, click the + symbol at the beginning of the connection row in question.

## CubPC software

The additional details are then displayed:

C839D4500000	Name	Calibration	Bump Test	Datalog	Firmware
+ 13/06/2012 10:30:35	Number 2	30/05/2012 16:29:45	No test	No Data	0.0.42
- 13/06/2012 10:38:30	Number 2	30/05/2012 16:29:45 Zero: 2732.1165 Span (50): 44085.2751	No test	13/06/2012 10:31:24   13/06/2012 10:31:24 Min 0.000 Max 91.87 STEL 0.272 TWA 0.008	0.0.42
+ 13/06/2012 10:41:59	Number 2	30/05/2012 16:29:45	No test	13/06/2012 10:39:06 	0.0.42

The Calibration column displays the zero and span levels that the Cub was calibrated to at the time.

The Data log column displays the minimum and maximum detected gas levels, and the detected STEL and TWA levels.

The column also displays an additional button for viewing details of the logged data (see below).

### Saving Logged Data to a CSV File



To save a data log to a CSV file, press this button in the Data log column for the log in question: The Export To CSV window is then displayed:

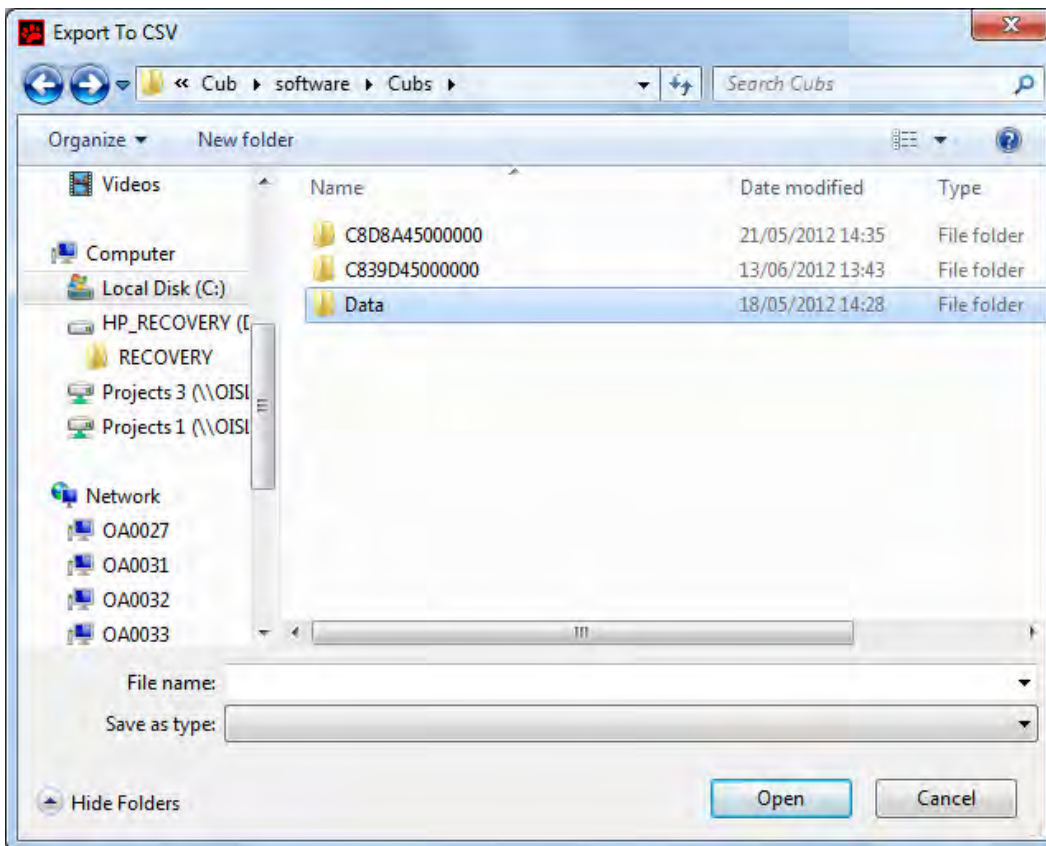

Browse to the folder that the file is to be saved into, enter its filename in the File Name field, and click Open to save the file.

Note that logged data may automatically be saved to a CSV when a Cub is connected to a docking station, depending on the options selected on the Preferences page.

## CubPC software

Note that logged data may automatically be saved to a CSV when a Cub is connected to a docking station, depending on the options selected on the Preferences page.

### Viewing Details of Logged Data



To view details of a data log, press this button in the Data log column for the log in question:

To view details of the most recent data log recorded by a Cub, press the same button on the Cubs page for the Cub in question.

The number on the button indicates how many files are stored within the Cub.

The details of the reading recorded in the selected log are then displayed. For example:

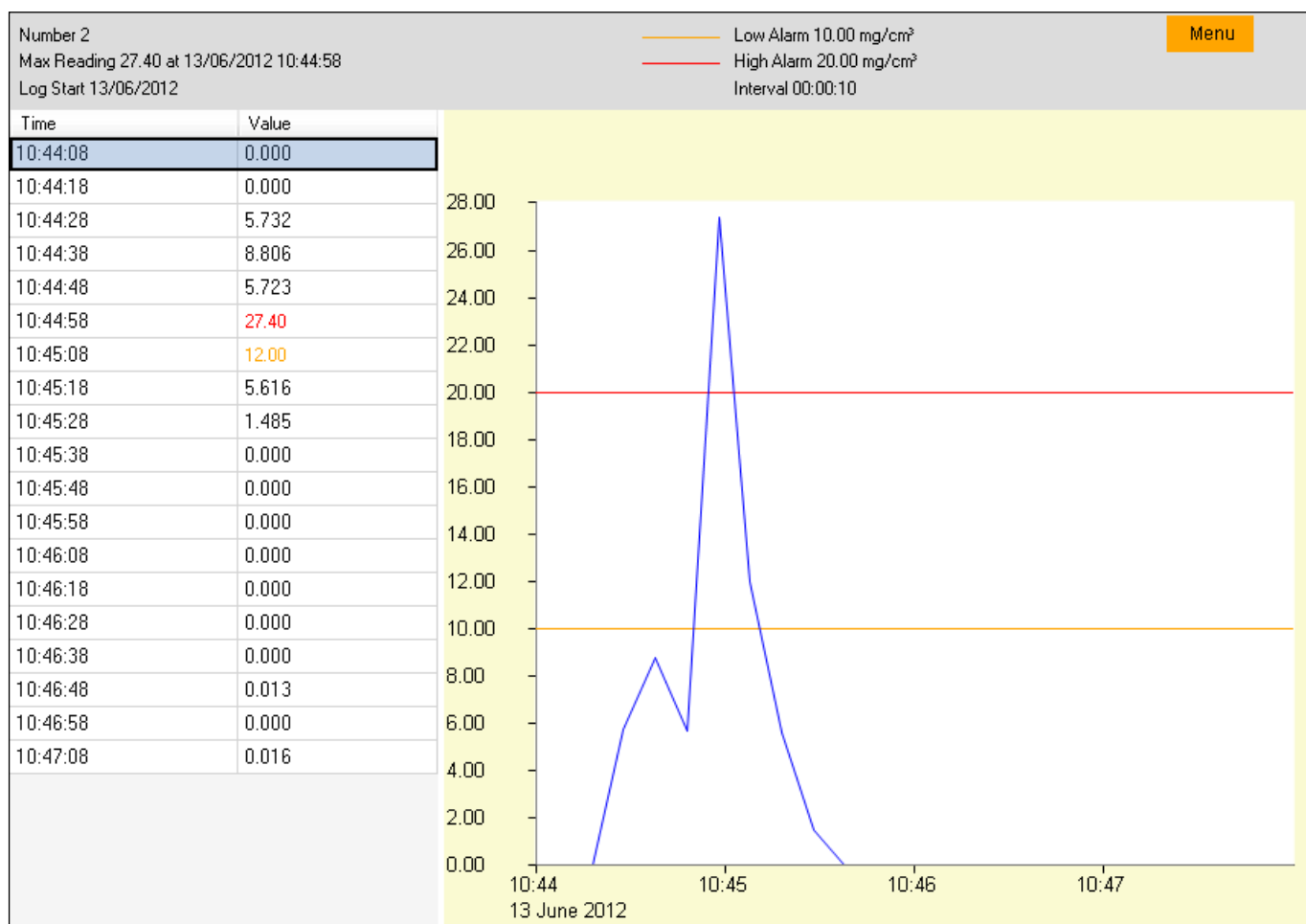

The log details page is divided into three areas.

The top area displays the following general details of the log: the name of the Cub, the maximum reading and when it was detected, when the log started, and the low alarm level, high alarm level and interval between readings set for the Cub (see Configuring a Cub above).

The left-hand area lists the time and recorded gas level of each reading. A reading value displayed in red indicates that the reading would have triggered a high level alarm. A reading value displayed in orange indicates that the reading would have triggered a low level alarm.

The right-hand area displays a line graph of the readings. The time is displayed along the X-axis. Gas levels are displayed along the Y-axis. The blue line indicates the recorded gas level. The red and orange lines indicate the high and low alarm levels respectively.

## CubPC software

If the table of readings is clicked on, a vertical green line is added to the graph to indicate the time of the reading. For example:

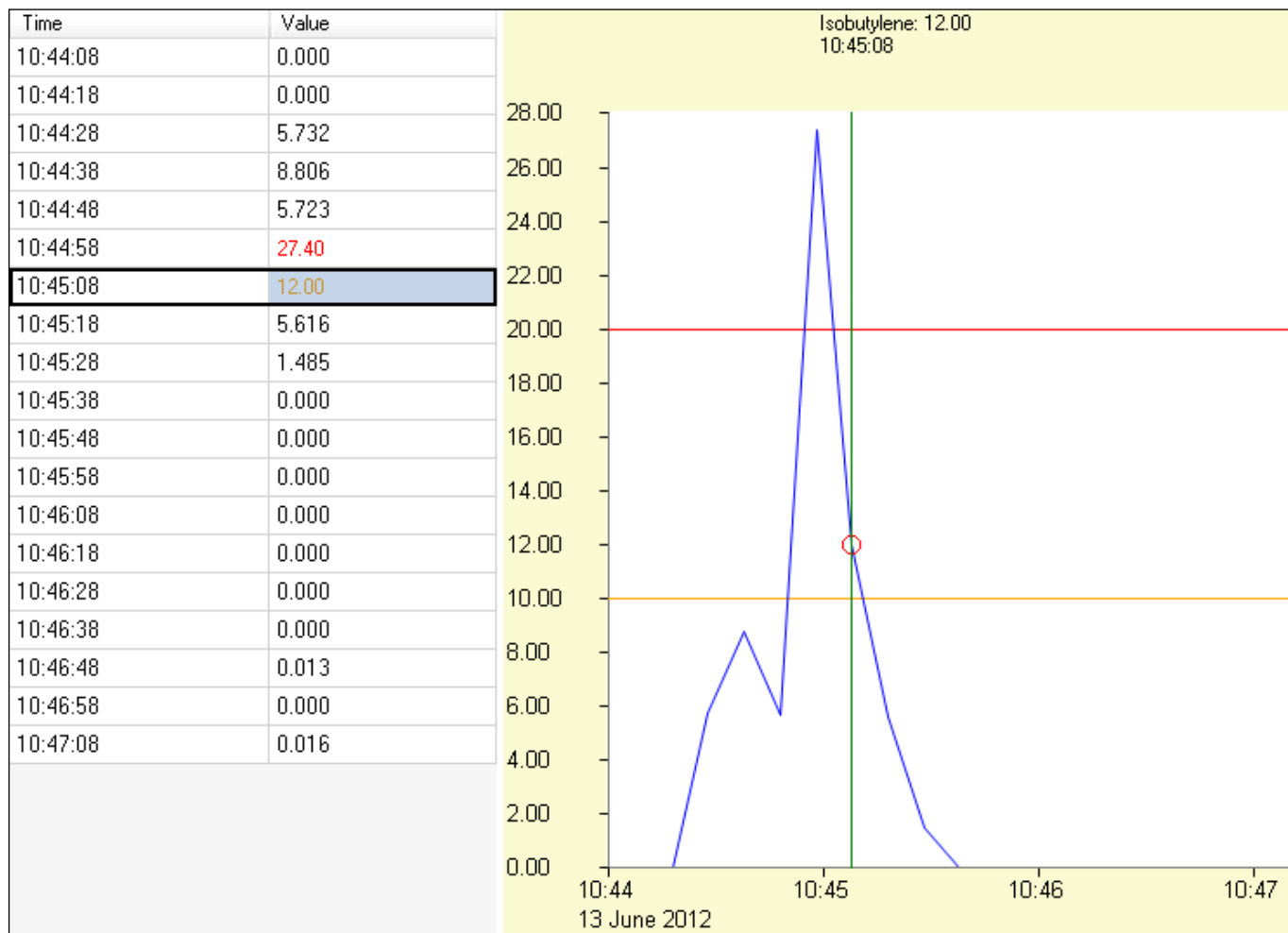

Above the line, the gas level at that time and exact time of the reading are displayed.

A green reading indicator line is also displayed if the graph is clicked on. The line will be displayed for the reading closest to the point that the graph was clicked.

Zoom into the graph by placing the cursor at the point that is to be zoomed into and rolling the mouse wheel down. Roll the mouse wheel up or press the right mouse button to zoom out.

Pressing the orange Menu button displays the following options:

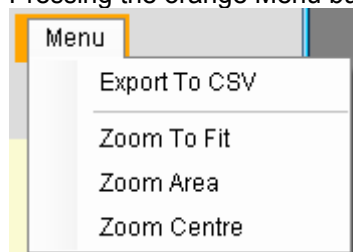

The Export to CSV option is used to export the log data to a CSV file. This

works in the same way as the  button on the data log overview page (see Saving Logged Data to a CSV File above).

The Zoom to Fit option is used to change the zoom level so that the entire graph is displayed at once (the graphs are displayed like this by default).

## CubPC software

---

The Zoom Area option is used to select an area to zoom into. When this option is selected, the cursor changes into a cross. Select the area to be zoomed into by holding down the left mouse button and dragging the cursor from one corner of the area to the opposite corner. A red box on the graph indicates the selected area. For example:

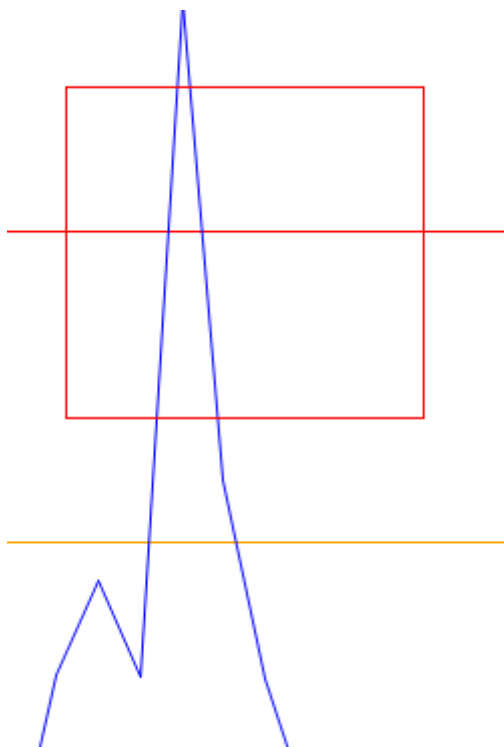

Release the mouse button to zoom into the selected area.

The Zoom to Centre option is used to centre the graph at a selected point on the graph and zoom into it. When this option is selected, the cursor changes into a four-headed arrow. Click on a point on the graph to centre the display on this point and zoom into it.

### Deleting all Logged Data

To delete a logged data currently stored by a Cub, press this button on the Cub's page for that Cub:



A message is then displayed requesting that the deletion be confirmed. Once confirmed, the deletion will take place.

### CAUTION:

**The delete function deletes all logged data from your Cub. Ensure any data you need to edit is exported to your PC in CSV format before selecting this option.**

## **CubPC software**

---

### **Software Disclaimers**

#### ***Termination of Software Licence***

This License is effective until terminated. This License will terminate automatically without notice from Ion Science Ltd if you fail to comply with any provision of this License. Upon termination, you agree to destroy, delete or purge the written materials and all copies of the SOFTWARE, including modified copies, if any.

#### ***Disclaimer of Warranty***

The SOFTWARE and accompanying materials (including the user's manual) are provided "as is" without warranty of any kind including the implied warranties of merchantability and fitness for a particular purpose, even if Ion Science Ltd have been advised of that purpose. Furthermore Ion Science Ltd does not warrant, guarantee, or make any representation regarding the use, or the results of the use, of the SOFTWARE or written materials in terms of correctness, accuracy, reliability, current revision, or otherwise. Ion Science Ltd specifically does not warrant the SOFTWARE after you assume operation. If the SOFTWARE or written materials are defective you, not Ion Science Ltd or its dealers, distributors, agents, or employees, assume the entire risk and costs of all necessary servicing, repair, or correction, except as stated below.

#### ***No Right to Reply***

No oral or written information or advice given by Ion Science Ltd, its dealers, distributors, agents or employees will create a warranty or in any way increase the scope of the obligations of Ion Science Ltd under this agreement, and you may not rely on any such information or advice.

#### ***Limitation of Liability***

Ion Science Ltd will not be liable for any direct, indirect, consequential or incidental damages (including damages for loss of business profits, business information, or possibility of such damages). The above limitation will apply where allowed under local laws.

#### ***Governing Law***

The laws of the United Kingdom govern this Agreement.

## Battery charging

---

### Warning

**BATTERY CHARGING:**                      **The Cub is a rechargeable device and should only be recharged in a Non Hazardous environment.**

### Recharging Battery

Ensure the Cub is charged for at least 4 hours before using it for the first time. The Cub should be charged in a non-hazardous environment only.

To charge your Cub, first connect the CubDoc Cub Docking Station which is connected to mains power. The Charge LED will indicate that power is on with a green light.

The Cub will then begin to charge. While the Cub is charging, the screen will be illuminated with a yellow light. When the Cub is fully charged, the screen will be illuminated with a green light.



While the Cub is connected to a docking station, the screen will display the level of charge.

**Note:** Ion Science Ltd recommends keeping your Cub on charge at all times when not in use, as batteries can lose power over time.

### Charging Pins

Two sprung loaded charging pins are located on the top of the docking station.

**Caution: Do not short circuit these two connections together else the internal fuse will blow and the Docking station will need to be returned to the manufacturer for replacement.**

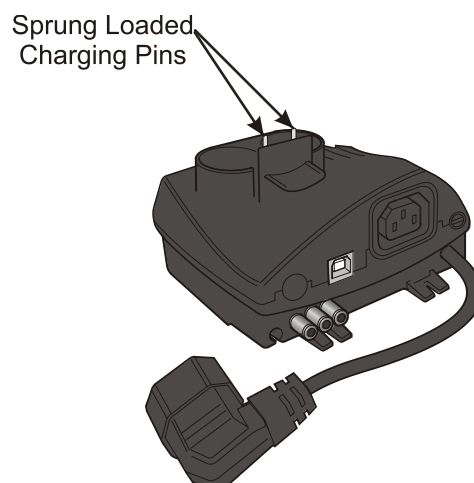



## **Diagnostics**

---

Error code	Description	Resolution
1	Sensor configuration error	Contact distributor
2	Flash memory error	Contact distributor
3	i2c bus error	Contact distributor
4	i2c bus to fuel gauge error	Contact distributor
5	Calibration fail	1. Check calibration setup 2. Check calibration gas connection to the calibration dock 3. Contact distributor
6	Sensor power	Contact distributor
7	Lamp strike fail	1. Replace lamp 2. Contact distributor
8	i2c ADC error	Contact distributor
9	ADC range error	Contact distributor
A	PID sensor connection issue	Contact distributor

## Maintenance

---

### Calibration

Ion Science Ltd recommends an annual service and calibration for users who require a traceable calibration. During this service the lamp and detector are brought back to factory specifications and a Factory Calibration is carried out and data logged.

Due to the linear output of the Ion Science PID detector, a two-point calibration is used. Cub scales its linear output across a ZERO level (clean air reference) and the SPAN 1 user defined gas concentration.

The Cub is calibrated at ion Science after manufacture; please note that subsequent calibration will overwrite the factory calibration. To calibrate the Cub first set up the parameters in Cub PC – see the 'Cub PC Software' section of the manual.

Ensure you have the cylinder(s) of gas, regulator(s) and / or a zero carbon filter for your Cub on hand before starting the procedure. Alternatively a known clean air supply may be used as the 'zero' gas. Please ensure you are familiar with the entire calibration procedure before attempting to calibrate your Cub.

If using a carbon canister for the Zero stage, use a short length of Tygon pipe to connect between the Carbon canister and the Calibration Zero inlet connector.

Connect the Zero and Span gas by pushing 5mm Tygon pipes onto the push fittings on the back of the Calibration docking station. Connect the Zero gas to the left position and Span gas to the right position.

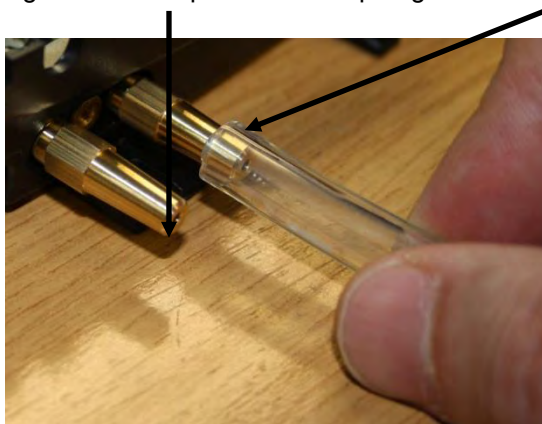

The middle position is unused.

The Zero and Span times will be affected by the length of pipework between the gas source and the Calibration dock. For best results, Ion Science recommends that lengths of pipework are kept to a minimum.

The shorter the length of pipework, the less gas is used to calibrate.

The table below assumes the use of 5mm ID Tygon pipe.

Pipe length	Zero Time (sec)	Span Time (sec)
100mm	10	22
200mm	12	24
300mm	14	26
400mm	16	28
500mm	18	30
600mm	20	32

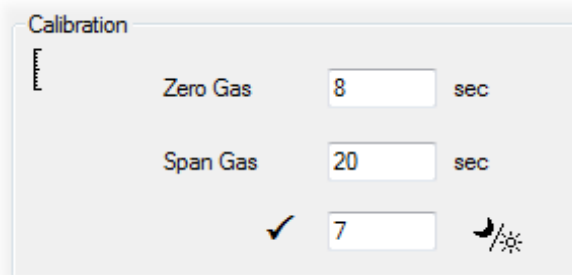

Minimum gas concentration is 2 ppm. Demand flow regulators must be used to supply gas to the calibration dock. They must be able to supply 0.3Litres per minute (300ml/min). The dock draws as much gas as it needs from the regulator (around 200 ml/min).

## Maintenance

On the Cub's page, click on this button for the Cub being calibrated: The calibration procedure is then initiated. The Calibration dock then pumps Zero gas and then Span gas to the sensor. If the calibration is successful a date time stamp will be shown in the calibration summary box. If the calibration fails the message "Invalid" appears on the Cub's page. If a calibration is invalid the Cub will revert to the previous calibration.



### Bump Test

To carry out a bump test on a Cub, apply the gas as described above, and click this button on the Cub's page for the Cub in question: The bump test is then carried out. The gas is applied and the test checks that the output reaches the levels specified in the preferences (see Configuring a Cub).

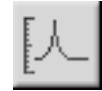

### Ingress of Water

If the Portable Cub has been subject to a deluge of water then it is necessary to shake the Cub vigorously to remove entrapped water from underneath the protective gauze lying above the filter located over the gas sensor. To ensure there is no impeding of gas through the filter to the gas filter replace, with new, the Filter Disc (2) and O Ring (3). (See below).

### PTFE Filter Disc (871026)

The Filter Disc (2) should be changed after every 100 hours of use. This frequency should be increased for dusty or moisture laden environments or whenever the filter appears 'dirty' when viewed by removing the Sensor Cover. Filter Disc changing should be conducted in a suitably clean environment, with clean hands and equipment to avoid contamination of the new Filter Disc.

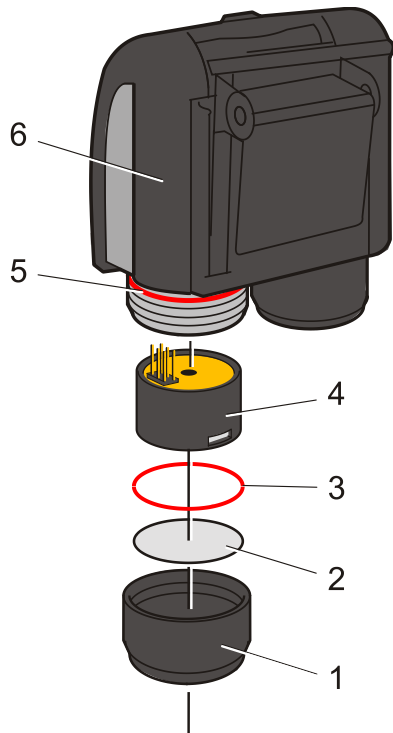

Item Number	Part Number
1	A-871027
2	871026
3	5/OO-108
4	(Multiple variants available)
5	5/OO-110
6	(Multiple variants available)

To change the Filter Disc (2), unscrew the Sensor Cover (1), and tap the Sensor Cover onto a suitable clean surface to dislodge the O Ring (3) and Filter Disc (2). Carefully place a new Filter Disc (2) in first and O Ring (3) in second into the Sensor Cover. **(Under no circumstances should a Filter Disc and O Ring be used once it has been removed.)** Make sure that O Ring (5) has remained in position. Then ensuring the Filter Disc (2) and O Ring (3) are correctly positioned, screw the Sensor Cover (1) onto the Instrument Body (6). Do not over-tighten.

## Maintenance

---

**Note:** With the Filter Disc (2) and O Rings (3 and 5) correctly fitted the Cub has a IP rating of 65 (independently tested by BASEEFA). With the Filter Disc and O Rings removed the IP rating will drop to 43.

### PID Sensor/Lamp Replacement and Cleaning

When using your Cub in conditions of high ambient humidity, the PID may show unexpected readings appearing to increase. This occurs due to dust or other small particles within the detector becoming hydrated with humidity. This causes these particles to conduct a signal between the electrodes. The problem can be resolved by the user in the field using the procedure below and a can of computer duster air. In normal use the lamp should be cleaned after every 100 hours of use (based on 30 ppm for 100 hours). Reduce this if Cub is used in heavily gas contaminated environments. Please note that some esters, amines and halogenated compounds may accelerate window fouling; in these cases cleaning may be required after every 20 hours of use. Cleaning frequency will also depend upon alarm levels set and prevailing environmental conditions.

### CAUTION!

**The Cub is a sensitive detector. Internal components must be handled with clean hands and clean tools. The Cub lamp is fragile. Handle with great care. Never touch the window and do not drop!!**

To remove the MiniPID Sensor (4) for cleaning or lamp replacement, first ensure that the Cub is turned off and that you are in a clean environment such that the sensor parts will not be contaminated by dust, oil or grease. Remove the Sensor Cover (1) (see image below). The Sensor Cover can be removed by unscrewing using your fingers.

Carefully lift/pull the MiniPID Sensor (4) from the Instrument Body (6)



Using the special Removal Tool MiniPID Stack (846216) provided, locate its 'prongs' in the slots in the side of the Mini PID Sensor body. Using the forefinger to restrain the sensor, (the internal parts are spring-loaded and careless disassembly will leave you hunting for the spring!) squeeze the tool to release the lamp housing.

The lamp may now be removed. To replace the lamp or install a new one, reverse the procedure.

**VERY IMPORTANT NOTE:** For the placement of Lamp into the Sensor body.

Place the MiniPID Stack on a flat surface – with the visible O'Ring and electrode stack uppermost.

The Lamp must be placed window face down onto the MiniPID Stack and gently rotated so that it is gripped snugly by the O'Ring.

Then the MiniPID sensor is carefully brought down over the back of the lamp and while carefully aligned with the resting MiniPID Stack, the sensor body is to be brought firmly down until the MiniPID Stack clicks into place onto the Sensor body.

This procedure ensures that lamp is firmly abutted the electrode stack for consistent and reliable VOC readings. Lamp placement by any other means is likely to give unreliable readings because the oring becomes entrapped between the window face and the electrode stack.

The instrument **MUST** be re-calibrated after fitting a replacement or cleaned lamp.

### CAUTION!

**Never refit a damaged lamp!**

## Maintenance

---

### Lamp Cleaning

The Cub PID relies on an ultraviolet light source ionising VOC gases as they pass across the lamp window. This process may result in a very fine layer of contamination appearing on the detector window that must be removed on a regular basis.

### CAUTION!

**The Cub is a sensitive detector. Internal components must be handled with clean hands and clean tools. The Cub lamp is fragile. Handle with great care!**

First ensure that the Cub is turned off and that you are in a clean environment such that the sensor parts will not be contaminated by dust, oil or grease.

Remove the lamp as detailed above.

Inspection of the lamp may reveal a layer of contamination on the detection window that presents itself as a 'blue hue.' To check for confirmation, hold the lamp in front of a light source and look across the window surface. Clean the window using the PID Lamp Cleaning Kit (A-31063) supplied.

### USE of PID Lamp Cleaning Kit A-31063

*The container of cleaning compound contains Aluminium Oxide as a very fine power (CAS Number 1344-28-1).*

*A full material safety data sheet MSDS is available on request from Ion Science Ltd. The key issues are listed below:*

*Always replace the lid after using the cleaning compound.*

### Hazard identification:

- May cause irritation of respiratory tract and eyes.

### Handling:

- Do not breathe vapour/dust. Avoid contact with skin, eyes and clothing;
- Wear suitable protective clothing;
- Follow industrial hygiene practices: Wash face and hands thoroughly with soap and water after use and before eating, drinking, smoking or applying cosmetics;
- The Compound has a TVL (TWA) of 10 mg/m<sup>3</sup>.

### Storage:

- Keep container closed to prevent water adsorption and contamination.

### To clean the lamp:

1. Open the vial of Aluminium Oxide polishing compound. With a clean cotton bud collect a small amount of compound;
2. Use this cotton bud to polish the PID lamp window. Use a circular action applying light pressure to clean the lamp window. Never touch the lamp window with fingers;
3. Continue polishing until an audible "squeaking" is made by the cotton bud with compound moving over the window surface (usually within fifteen seconds);
4. Remove the residual powder with short blast of air from the can of air duster;
5. Replace the lamp holder into the MiniPID Sensor. Noting the procedure of lamp fitment given earlier under "Very Important Note".
6. Align the six pins on the MiniPID Sensor (4) into the Instrument Body (6) and push in until fitted.
7. Replace Sensor Cover (1) by screwing until finger tight.
8. The instrument MUST now be re-calibrated.



**Cub parts**

---

<b>Item Number</b>	<b>Part Number</b>	<b>Description</b>
1	871026	PTFE Filter Membrane
2	5/OO-108	O'Ring Seal 18mm
3	A-846267	Pellet burnt (PPB)
4	A-846417	Pellet burnt (10eV)
5	LA4TM600	MiniPID Lamp Krypton 10.6eV ppm TIGER
6	MP6SX6FX	MiniPID 6-pin 10.6eV
7	MP6SX6PX	MiniPID 6-pin 10.0eV
8	846217	Spring (for MiniPID)

## Accessories

---

Ion Science Ltd has developed an exclusive range of high quality accessories to compliment the Cub. Please see a selection of these below:

Item Number	Part Number	Description
1	A-871027	Cub Cap Moulding Complete
2	871037	Cub Docking Mounting Bracket Moulding
3	871200	Gas Saturation Cup
4	871202	Quick Start Guide – Cub
5	A-871019	Cub Belt Clip Complete
6	A-871205	Cub Accessory Kit
7	846216	Removal tool MiniPID stack
8	A-31063	PID Lamp Cleaning Kit
9	A-845214	PhoCheck Demand Calibration Kit
10	1/VC-22	Cable USB 2.0 A to B, 2m

For more information please visit [www.ionscience.com/cub](http://www.ionscience.com/cub) and click on the Accessories tab.

## **Instrument warranty and service**

---

### **Warranty**

Standard Warranty can be extended to up to 2 years on the Cub when registering your instrument via our website: [www.ionscience.com/instrument-registration](http://www.ionscience.com/instrument-registration)

To receive your Extended Warranty, you need to register within one month of purchase (Terms and Conditions apply). You will then receive a confirmation email that your Extended Warranty Period has been activated and processed.

Full details, along with a copy of our Warranty Statement can be found by visiting: [www.ionscience.com/instrument-registration](http://www.ionscience.com/instrument-registration)

### **Service**

Ion Science is pleased to offer a number of service options on our Cub product range that allow you to choose the instrument cover that best suits your needs.

At Ion Science we recommend that all of our gas detection instruments be returned for service and factory calibration once every 12 months.

Contact Ion Science or your local distributor for service options in your area.



## **Technical specifications**

---

<b>Response time:</b>	T90 < 13 second	
<b>Detectable Range:</b>	1 ppb – 10,000 ppm & ppb to 20,000ppm for Specific Gases	
<b>Resolution:</b>	+/- 1 ppb	
<b>Accuracy:</b>	+/- 5% displayed reading +/- one digit	
<b>Linearity:</b>	+/- 5% displayed reading +/- one digit	
<b>Battery:</b>	Lithium ion:	16 hours
<b>Data log:</b>	Including date / time:	30000
<b>Alarm visual:</b>	Flashing Red and Amber LED	
<b>Alarm audible:</b>	86 dB @ 300 mm	
<b>Flow Rate:</b>	≥ 220 ml/min in Ambient conditions	
<b>Temperature:</b>	Operating:	-20 to 60 °C (-4 to 140 °F)
	Storage:	-25 to 60 °C (-13 to 140 °F)
	Certified to:	-15 to 45 °C (-5 to 140 °F)
<b>Dimensions:</b>	Instrument:	61mm x 66mm x 55mm (2.4" x 2.6" x 2.2")
<b>Weight:</b>	Instrument:	111g (3.9 oz)

## Manual log

---

Manual version	Amendment	Issue date	Dock firmware	Instrument firmware	PC software
1.0	Original	18/06/12	0.0.11	0.0.50	0.0.0.19
1.1	PC graphics update + addition of calibration time table (p. 33) + Updated fault diagnostics (p. 21) + High & Low alarm graphics (p. 10)	14/08/12	0.0.12	0.0.51	0.0.0.21
1.2	Addition of remote calibration purge table and related text (p.12)	11/10/2012	n/a	n/a	n/a
1.3	Minor text change to the IMPORTANT notice on page 12. Minimum requirements for host PC regarding .net 3.5 SP1 (p.13)	16/10/2012	n/a	0.0.53	0.0.0.22
1.4	Manual format and layout updated	08/01/2013	n/a	0.0.53	0.0.0.22
	Mains power input 100Vac (page 7) + Custom calibration routine (page 14)	15/01/2013		0.0.59	0.0.0.29
1.5	Message added to IS statements (page 3) "Continuous exposure to wet weather conditions should be limited to less than one day and harsh water spray conditions should be avoided."	15/02/2013	n/a	n/a	n/a
	Page 40 audible alarm level changed. Format changes to outside front cover, instrument registration text added to inside front cover. Minor text and format changes throughout.	13/03/2013			
1.6	Addition of label graphic and two text updates on the Declaration of conformity, along with including standard 61010-1:2010	14/03/2013	n/a	n/a	n/a
	Caution note added to page 8 under Batteries heading	30/05/13	n/a	n/a	n/a
	Addition of error code A – page 33	10/06/13	n/a	0.0.61	n/a
1.7	Parts list added to page 35. Firmware update	29/07/2013	n/a	0.0.65	n/a