

Operating Manual

ALTAIR Single Gas Detector



MSA AUER GmbH
D-12059 Berlin
Thiemannstraße 1
Germany

© MSA AUER GmbH. All rights reserved



Declaration of Conformity

Mine Safety Appliances Company
MANUFACTURED BY: 1000 Cranberry Woods Drive
Cranberry Township, PA 16066 USA

The manufacturer or the European Authorized Representative

MSA AUER GmbH, Thiemannstrasse 1, D-12059 Berlin

declares that the product **MSA ALTAIR**

Complies with the provisions of the council directive 94/9/EC (ATEX).
This declaration is based on the EC-Type Examination Certificate

FTZU 05 ATEX 0250

FTZU, Ostrava, Czech Republic, in accordance with Annex III of the
ATEX Directive 94/9/EC.

Quality Assurance Notification issued by Ineris of France, Notified Body number
0080, in accordance with Annex IV and Annex VII of the ATEX Directive 94/9/EC.
We additionally declare that this product is in conformance with the EMC Directive
89/336/EEC in accordance with the standards

EN 61000-6-2 and EN 61000-6-4

A handwritten signature in black ink, appearing to read 'Dr. A. Schubert', written in a cursive style.

MSA AUER GmbH
Dr. Axel Schubert
R & D Instruments

Berlin, February 2006

Contents

1.	Safety Regulations	5
1.1.	Correct Use	5
1.2.	Liability Information	5
1.3.	Safety and Precautionary Measures to be Adopted	6
2.	Description.....	7
2.1.	Instrument overview	7
2.2.	On-screen Indicators	8
2.3.	Monitoring toxic gases	9
2.4.	Monitoring the oxygen concentration	10
2.5.	Duration of use of the instrument	11
3.	Operation	12
3.1.	Setting the alarm setpoints before commissioning	12
3.2.	Commissioning the instrument	14
3.3.	Displaying the instrument data	16
3.4.	Event logging	18
3.5.	Function tests on the instrument	19
3.6.	Calibrating the instrument	21
4.	Maintenance.....	27
5.	Technical specifications/Certifications	28
5.1.	Technical specifications of the ALTAIR.....	28
5.2.	Test gases table	29
5.3.	Certifications	29
6.	Order Information	30

1. Safety Regulations

1.1. Correct Use

The ALTAIR is a portable instrument for monitoring toxic gases and oxygen deficiency or excess in the workplace. It is used exclusively for monitoring and not for measuring gas concentrations in the ambient air. It must be serviced and repaired by qualified and authorised personnel.

It is imperative that this operating manual be read and observed when using this instrument. In particular, the safety instructions, as well as the information for the use and operation of the apparatus, must be carefully read and observed. Furthermore, the national regulations applicable in the user's country must be taken into account for a safe use.



Attention!

This product is supporting life and health. Inappropriate use, maintenance or servicing may affect the function of the device and thereby seriously compromise the user's life.

Before use, the product operability must be verified. The product must not be used if the function test is unsuccessful, it is damaged, a competent servicing/maintenance has not been made, genuine MSA spare parts have not been used.

Alternative use, or use outside this specification, will be considered as non-compliance. This also applies especially to unauthorised alterations to the apparatus and to commissioning work that has not been carried out by MSA or authorised persons.

1.2. Liability Information

MSA accepts no liability in cases where the product has been used inappropriately or not as intended. The selection and use of the product are the exclusive responsibility of the individual operator.

Product liability claims, warranties also as guarantees made by MSA with respect to the product are voided, if it is not used, serviced or maintained in accordance with the instructions in this manual.

1.3. Safety and Precautionary Measures to be Adopted

**Attention!**

The following safety instructions must be observed implicitly. Only in this way can the safety and health of the individual operators, and the correct functioning of the instrument, be guaranteed.

Use instrument only for stipulated gases

The ALTAIR is used for monitoring and detecting gases in the ambient air. Thereby, it must be used only for gases for which a sensor is installed in the instrument.

The sensor must not be blocked during use.

Observe oxygen concentration

The instrument is actuated on oxygen concentrations up to 25%. However, note that all instrument versions are calibrated and permitted only for an oxygen concentration of up to 21.0%.

Check function and alarm before each use

In case of failed function tests, the instrument must be removed from use.

Conduct additional tests after loading

The instrument function should also be checked after severe mechanical stress (dropping, impact etc.) and when the instrument or the sensors have been exposed to silicon, silicates, lead-containing substances, hydrogen sulphide or contaminated compounds.

Defective vibration alarm possible

At ambient temperatures $< 0^{\circ}\text{C}$, the vibration alarm can give a false alarm or can fail completely. In such conditions, do not rely solely on the vibration alarm.

No maintenance required and possible

During its service life of approx. 24 months, no maintenance of any kind is required on the instrument. Do not try to carry out any kind of maintenance tasks or repairs whatsoever on the instrument.

In case of faults or expiry of the service life, dispose off the instrument in compliance with the applicable regulations.

Observe BG information

In Germany, observe the BG information BGI 836 (5).

2. Description

2.1. Instrument overview



Fig. 1 Instrument view

- | | | | |
|---|----------------------------|---|---------------------|
| 1 | Alarm LED | 5 | Test button |
| 2 | Infrared port | 6 | Display |
| 3 | Sensor cover | 7 | Stipulated gas type |
| 4 | Acoustic alarm transmitter | | |

The instrument is a portable gas meter for monitoring gases and vapours in the ambient air and in the workplace. It is used exclusively for monitoring and cannot be used for measuring gas concentrations.

The instrument is available in three models:

- for monitoring oxygen
- for monitoring hydrogen sulphide and
- for monitoring carbon monoxide



The instrument can detect up to 25% oxygen in the ambient air. However, all instrument models are calibrated and permitted only up to 21% oxygen-content.

The response levels for the individual gases are set at the factory and cannot be changed during operation. After commissioning the instrument, changes are possible only with the MSA FiveStar® Link™ software (available as option; → Description of software).

After commissioning the instrument, the remaining operation time is displayed in months.



If the ambient air contains higher gas concentrations, the instrument ignores the Fresh Air Setup and goes directly to measuring mode after the self-test.

2.2. On-screen Indicators

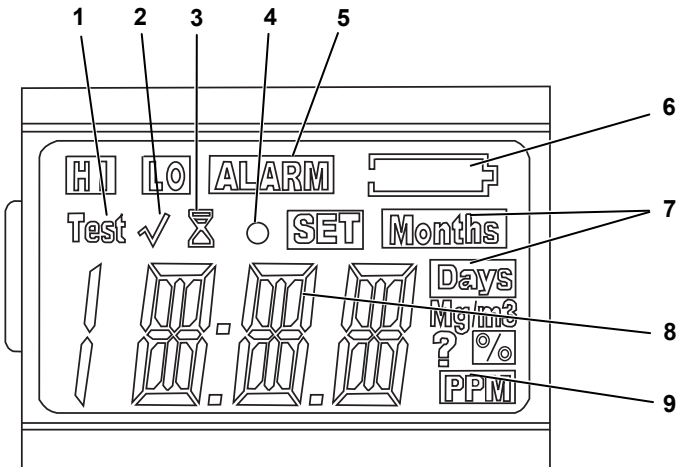

Fig. 2 Display

- 1 Self-test in progress
- 2 Bump check indicator
- 3 Alarm duration (hour glass)
- 4 Ready indicator
- 5 Alarm indicator
- 6 Battery warning indicator
- 7 Remaining operation time unit
- 8 Numeric indicator
- 9 Gas concentration units

2.3. Monitoring toxic gases

With the ALTAIR, you can monitor the concentration of the following toxic gases in the ambient air:

- Carbon monoxide (CO)
- Hydrogen sulphide (H₂S)

**Attention!**

If an alarm is triggered while using the instrument as a monitor, leave the area immediately.

Remaining on site under such circumstances can cause serious damage to health or can even lead to death.

Two alarm thresholds on the instrument are preset at the factory (Minimum "LO" and Maximum "HI").

On reaching or exceeding one of these alarm thresholds:

- the alarm is displayed in the display ("LO ALARM" or "HI ALARM") and
- the corresponding alarm is triggered.

In both cases, the acoustic alarm can be shut off for five seconds by pressing the test button. As soon as the gas concentration is in the normal range again, the alarm is terminated automatically.

The alarm is presented in the following manner:

- an acoustic signal sounds,
- the alarm LEDs flash,
- a vibration alarm is triggered and
- in the display, "ALARM" is displayed in combination with "LO" or "HI" and the corresponding gas concentration.

2.4. Monitoring the oxygen concentration

With the ALTAIR, the oxygen concentration is monitored in the atmosphere. The alarm setpoints can be set to enrichment (concentration > 20.8%) or depletion (concentration < 20.8%).



Attention!

If an alarm is triggered while using the instrument as a monitor, leave the area immediately.

Remaining on site under such circumstances can cause serious damage to health or can even lead to death.

When a set value is reached, an alarm is triggered:

- an acoustic signal sounds,
- alarm LEDs flash,
- a vibration alarm is triggered and
- in the display, "ALARM" is displayed in combination with "LO" or "HI" and the corresponding oxygen concentration.



In the event of extreme changes in the air pressure or the atmospheric temperature, a false alarm can be triggered.

Therefore, calibrate the instrument under conditions of use.

2.5. Duration of use of the instrument

Normal operation

In normal operation, the instrument displays the remaining operation time in months (0 - 24). If less than a month of operation time remains the displays switches to days.

The instrument is designed in such a way that it will continue to function even after the duration of use expires. In this case, it is shown with a "+" in front of the display.

For problem-free operation of the instrument, even over the normal duration of use of 24 months, carry out a function test before each use.

The instrument is ready for operation

- as long as the battery warning indicator (Pos. 6 in Fig. 2) does not display **and**
- the self-test is successful.

Weakening battery

A weakening battery is indicated by

- the flashing battery warning indicator and
- the remaining operation time indicator going off.



Attention!

You are not allowed to use the instrument even if it still shows a gas concentration.

Flat battery

A flat battery triggers the following alarm:

- an acoustic signal sounds,
- alarm LEDs flash,
- battery warning indicator flashes and
- the display shows "ERR".



The alarm can be turned off by pressing the test button.



Attention!

It is not permitted to continue to use the instrument!
The instrument must be taken out of use.

3. Operation

3.1. Setting the alarm setpoints before commissioning

- (1) Press [TEST] key once.
 - TEST is displayed;
 - After about 1 s, all display indicators are activated;
 - Acoustic alarm sounds, alarm LEDs light up and vibration alarm is triggered;
 - The software version is displayed for approx. 3 s;
 - The gas type is displayed for approx. 3 s more (O₂, H₂S or CO).
 - LO and ALARM as well as HI and ALARM are displayed alternately for approx. 3 s.
- (2) To set the prealarm (LO), press the [TEST] key when "LO" and "ALARM" displays.
 - "LO", "ALARM", "SET" and "?" are displayed.
- (3) By pressing the [TEST] key, increase the value for the pre-alarm, until the desired value is reached.
 - On obtaining the maximum value, the display jumps and begins to count upwards again with minimum value.
- (4) Release [TEST] key and wait for 3 s.
- (5) To set the main alarm (HI), press the [TEST] key when "HI" and "ALARM" displays.
 - "HI", "ALARM", "SET" and "?" are displayed.
- (6) By pressing the [TEST] key, increase the value for the pre-alarm, until the desired value is reached.
 - On obtaining the maximum value, the display jumps back and begins to count upwards again from the minimum value.
- (7) Release [TEST] key and wait 3 s.
 - Instrument shuts off.

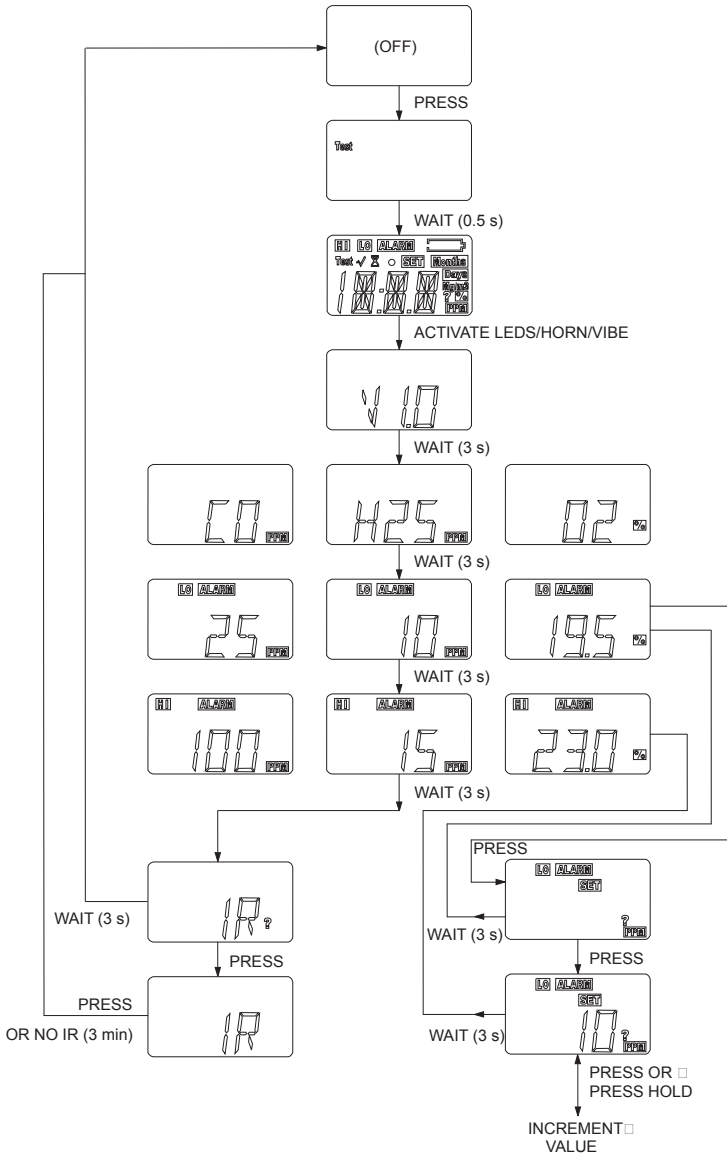

Fig. 3 Setting the alarm setpoints

3.2. Commissioning the instrument



Before the instrument can be used for monitoring possible toxic gases in the atmosphere, it must be commissioned.

- (1) Press and hold [TEST] key for 3 s, until "ON" and "?" are displayed.
 - (2) Release [TEST] key and press again.
 - After about 1 s, all display indicators are activated;
 - Acoustic alarm sounds, alarm LEDs light up and vibration alarm is triggered;
 - The software version is displayed for approx. 3 s;
 - The gas type is displayed for approx. 3 s more (O₂, H₂S or CO).
 - LO and ALARM as well as HI and ALARM are displayed alternately for approx. 3 s.
-



During the display of LO and ALARM as well as HI and ALARM, the corresponding setpoints can still be changed (→ Section 3.1).

- (3) Release [TEST] key and wait for 3 s.
 - Instrument begins an activation cycle of 99 s duration (countdown).
 - After activation, the remaining operation time is displayed in months.
 - The ready indicator lights up every 60 s and the alarm LEDs light up briefly.
-



After successful activation, the instrument remains active without interruption until the battery is flat.

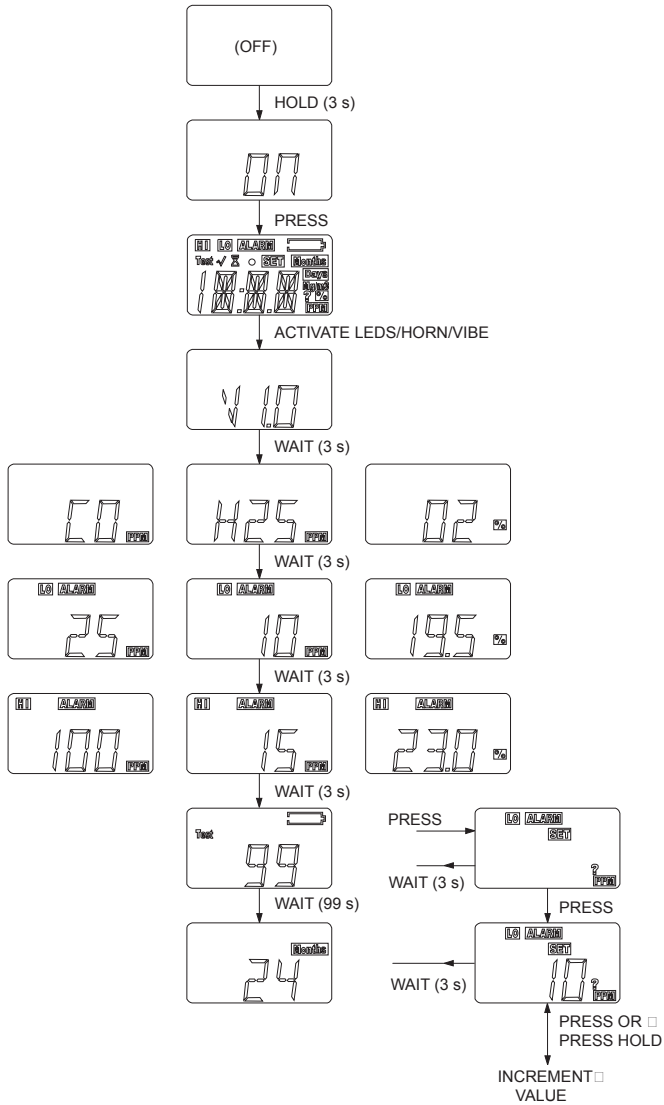

Fig. 4 Starting the instrument

3.3. Displaying the instrument data

- (1) By pressing the [TEST] key, the stored instrument data can be called up (→ Fig. 5).

This includes:

- the current gas concentration
- the test gas mode
- the value for the lower reaction point ("LO" "ALARM")
- the value for the upper reaction point ("HI" "ALARM")
- the minimum oxygen concentration ("LO") – only for oxygen version
- the measured peak values ("HI", "LO")



The measured peak values can be deleted. For this, press the test button when displaying the relevant value.

During the display of the peak value, press the [TEST] key:

- Value is deleted
- "CLR" is displayed
- The alarm duration in hours (hour glass, "HRS" and numeric value)
- The IR mode
 - If an IR interface is detected in the test mode, the instrument bypasses the IR mode.
 - If no IR interface is detected in test mode within 30 s, or the [TEST] key is pressed, the instrument exits this mode.

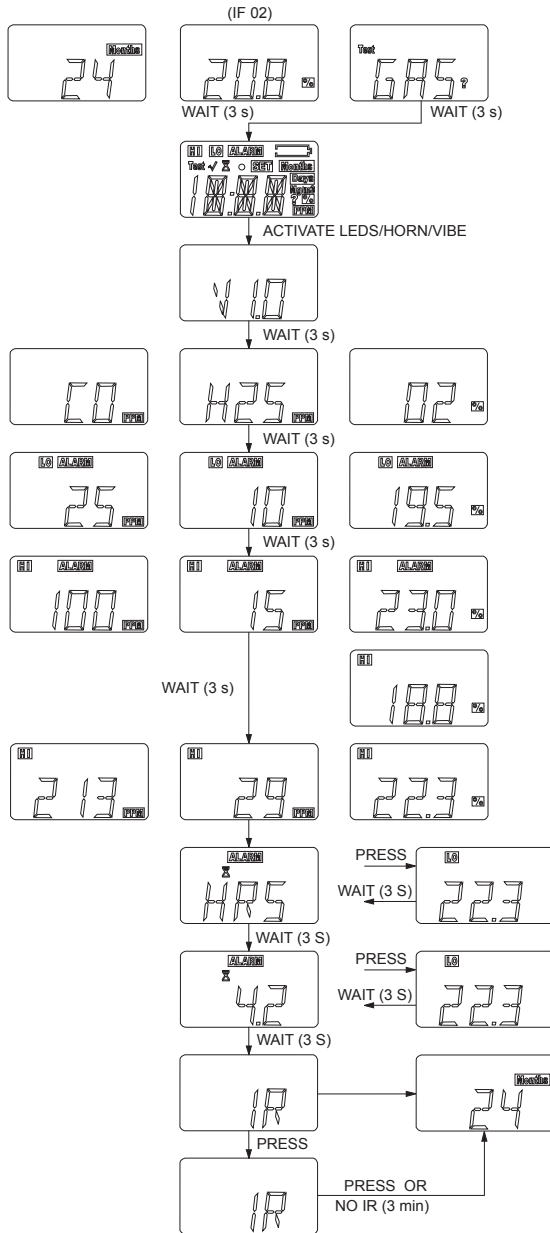

Fig. 5 Calling instrument information up

3.4. Event logging

The instrument can log up to 25 of the most important events.

These can be called up and displayed with a PC and the optional MSA FiveStar®Link™ software (→ Description of FiveStar®Link™ software). For this, the instrument must be connected to the PC via an IR interface.

Stored events

- **Alarm**
Alarm type – Alarm value – Time/Date
- **Reset alarm**
Alarm type – Alarm value – Time/Date
- **Calibration**
(pass/fail) – Time/Date
- **Self-test**
(pass/fail) – Time/Date
- **Error**
Error type (→ Troubleshooting in Section 4)
- **End of life**
Reason (Error messages → Troubleshooting in Section 4) – Alarm duration (in minutes) – Life (in months) – Time/Date

Connecting instrument to PC

- (1) Switch on PC and align instrument to the IR interface of the PC.
- (2) Press the [TEST] key on the instrument.
 - Instrument data will be displayed (→ Section 3.3)
- (3) Start the MSA FiveStar®Link™ software in the PC and start connection by double-clicking "CONNECT".



The date and time display are based on the computer time.
Make sure that the date and time on the computer are correct.

3.5. Function tests on the instrument

Checking the ready indicator

The alarm LEDs and the ready indicator in the display must flash every 60 s after starting the instrument.

Alarm test



The alarm test must be conducted before each use.
It is part of the self-test.

- (1) Briefly press the [TEST] key.
A short alarm is triggered. These include:
 - temporary display indicators;
 - alarm LEDs flash;
 - acoustic signal sounds briefly and
 - vibration alarm is triggered briefly.

Self-test



The self-test (→ Fig. 6) must be conducted before each use.

- (1) Briefly press the [TEST] key.
 - In the oxygen version, the set oxygen concentration is displayed. Calibration (→ Section 3.6) must be carried out if the value deviates from 20.8%!
 - "TEST" "GAS" "?" is displayed.
 - The alarm test (see above) is triggered.
- (2) Press the [TEST] key again if "TEST" "GAS" "?" is displayed.
 - Hour glass and "GAS" are displayed
- (3) Feed test gas into the instrument (possible test gases → "Test gases" table in Section 5.2).
 - "OK" is displayed.
- (4) Press the [TEST] key again.
 - In addition to the remaining operation time, a "✓" is displayed for 24 hours to indicate that the self-test was successful.

If this display does not appear and "ERR" is displayed, check:

- whether the sensor is dirty,
- whether the correct test gas was used,
- whether the test gas cylinder is empty or the date has expired,
- whether the test gas was fed in at the right moment,
- whether the test gas hose was connected to the sensor.

(5) Repeat the self-test if necessary.

(6) If the self-test fails, calibrate the instrument (→ Section 3.6).

(7) Repeat the self-test after the calibration.

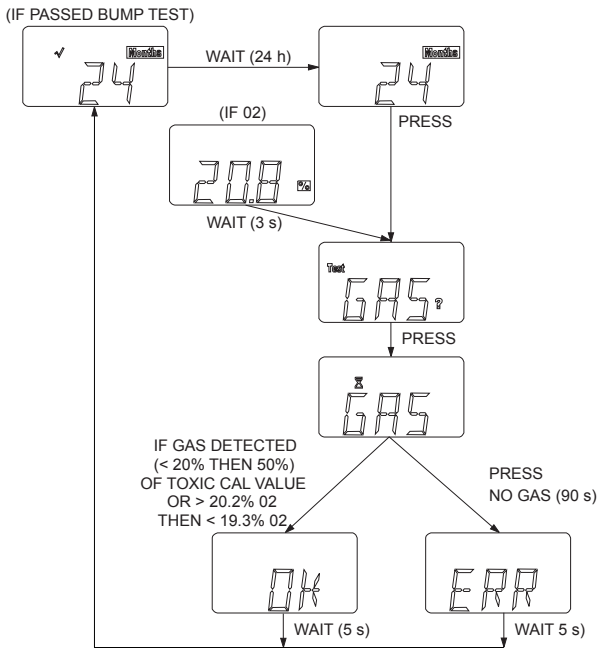

Fig. 6 Conducting the self-test

▪

3.6. Calibrating the instrument

Although the instrument is maintenance-free, it must be calibrated if the self-test has failed. Similarly, certain national regulations may stipulate the calibration of the instrument.

For instruments used to monitor oxygen calibration must be carried out in the following cases:

- any change in the air pressure (including height above sea-level change),
- any extreme changes in the atmospheric temperature,
- if the self-test failed.

For instruments used to monitor toxic gases (CO and H₂S), calibration must be carried out in the following cases:

- after major shocks,
- any extreme changes in the atmospheric temperature,
- after use under high gas concentrations,
- if the self-test failed.

Calibration - Toxic gases



Make sure that the calibration is carried out in clean, non-contaminated ambient air.

Carry out the calibration as follows (also see Fig. 7 and Fig. 8):

- (1) Press [TEST] key
 - "TEST" "GAS" "?" is displayed.
- (2) Press and hold [TEST] key for 3 s.
 - "TEST" "CAL" is displayed.
 - After 3 s, "FAS" "?" is displayed which prompts the user to do a fresh air equalisation.
- (3) During the "FAS" "?" display, press the [TEST] key to do a fresh air equalisation.



If no fresh air equalisation is carried out, the instrument returns to normal operating mode.

- During the equalisation, the hour glass and "FAS" are displayed.
- If the equalisation fails ("ERR" display), the instrument returns to normal operating mode after 5 s.

- (4) If the equalisation is successful ("OK" display), press the [TEST] key and begin the calibration.
 - "CAL" "?" is displayed.
- (5) During the "CAL" "?" display, press the [TEST] key and start the calibration mode.
 - The value for the test gas in ppm is displayed.
- (6) To change the value, press and hold the [TEST] key, until the desired value is set.
 - The new value for the test gas in ppm is displayed.
 - After 3 s, the instrument returns to the calibration mode.
- (6) Feed test gas into the instrument (possible test gases → "Test gases" table in Section 5.2).

**Attention!**

The concentration of the test gas used must match the stipulated value in the "Test gases" table in Section 5.2 for the relevant instrument.

Otherwise, the calibration is not carried out correctly. If there is a fault, it can lead to serious damage to health or even to death.

- The gas value, hour glass and "CAL" are displayed alternately.
 - If calibration is successful, after approx. 90 s "OK" is displayed and the instrument returns to normal operating mode after 5 s.
 - If calibration **fails**, "ERR" is displayed and the instrument returns to normal operating mode after 5 s.
 - The current values were not changed.
- (7) If calibration fails, check:
 - whether the correct test gas was used,
 - whether the test gas cylinder is empty or the date has expired,
 - whether the test gas hose was connected to the sensor,
 - whether the flow governor is set to 0.25 l/min.
 - (8) If necessary, repeat steps (1) to (7).
 - "OK" is displayed. Otherwise ("ERR"), the instrument must be taken out of use.
 - (9) Conduct a self-test to confirm the calibration.
 - If the self-test is successful, a "✓" is displayed.

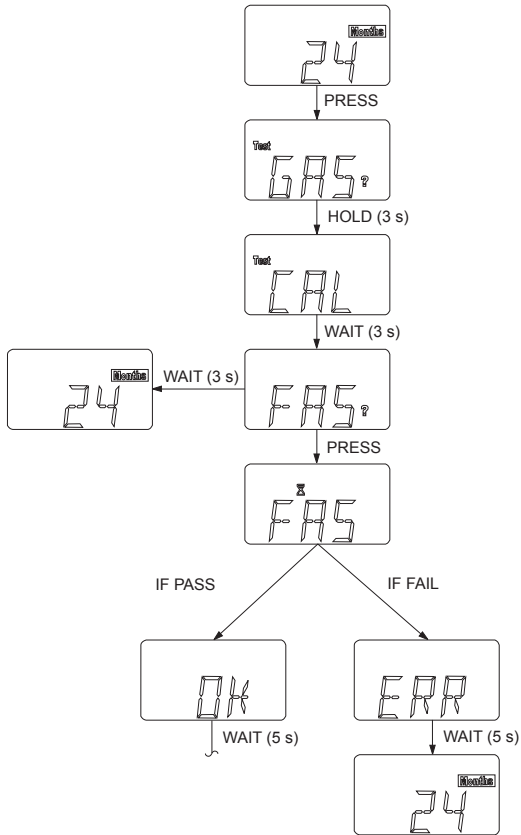

Fig. 7 Calibration - Toxic gases

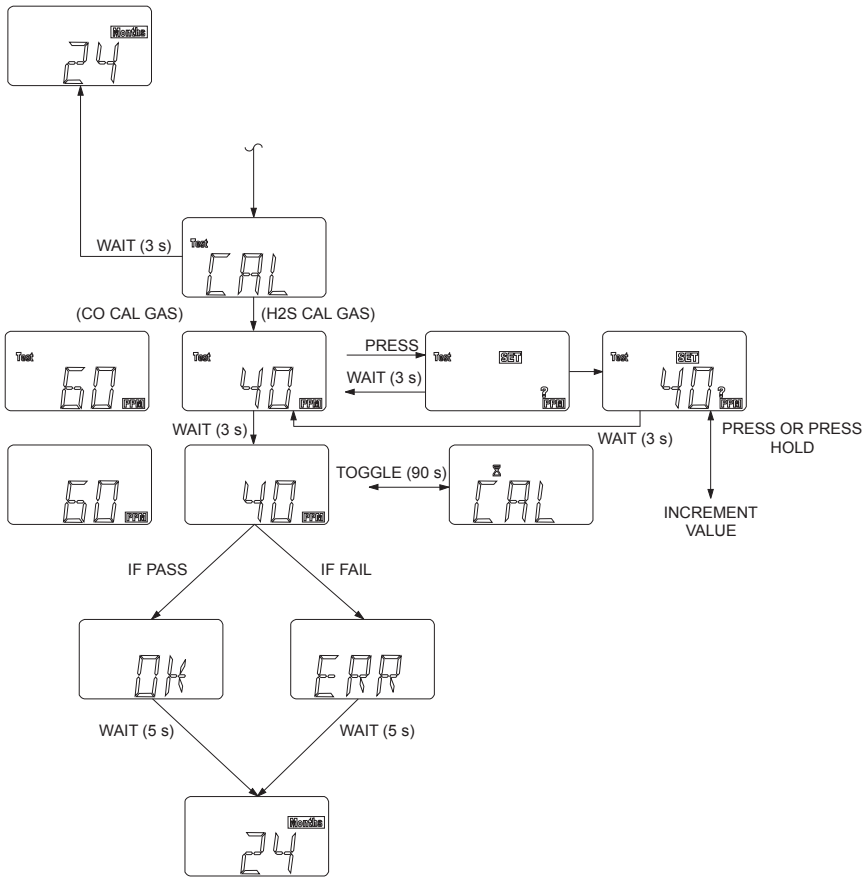

Fig. 8 Calibration – Toxic gases (continued)

Calibration – Oxygen



Attention!

The instrument must be calibrated if, during operation, a value different from 20.8% oxygen in the ambient air is displayed.



In the event of extreme changes in the air pressure or the atmospheric temperature, false alarms can be created.

Therefore, calibrate the instrument under the conditions of use. The calibration must be carried out in clean, non-contaminated ambient air.

Carry out the calibration as follows:

- (1) Press [TEST] key
 - The current oxygen concentration is displayed.
 - The display switches to "TEST" "GAS" "?".
- (2) During the "TEST" "GAS" "?" display, press and hold the [TEST] key.
 - "GAS" "CAL" is displayed.
 - After 3 s, "FAS" "?" is displayed which prompts the user to do a fresh air equalisation.
- (3) During the "FAS" "?" display, press the [TEST] key to do a fresh air equalisation.



The fresh air equalisation must be carried out in clean, non-contaminated ambient air.

During the process, do not breathe on the sensor.



If no fresh air equalisation is carried out, the instrument returns to normal operating mode.

- During the equalisation, the hour glass and "FAS" are displayed.
 - If the equalisation is successful, "OK" is displayed
 - If equalisation **fails**, "ERR" is displayed and the instrument returns to normal operating mode after 5 s.
The current values were not changed.
- (4) If calibration fails, check:
 - that the equalisation was carried out in clean ambient air,
 - that during the equalisation, you did not breath on the sensor.
 - (5) If necessary, repeat the steps (1) to (4).
 - "OK" is displayed. Otherwise ("ERR"), the instrument must be taken out of use.
 - (6) Conduct sel f-test to confirm the calibration.
 - If the self-test is successful, a "✓" is displayed.

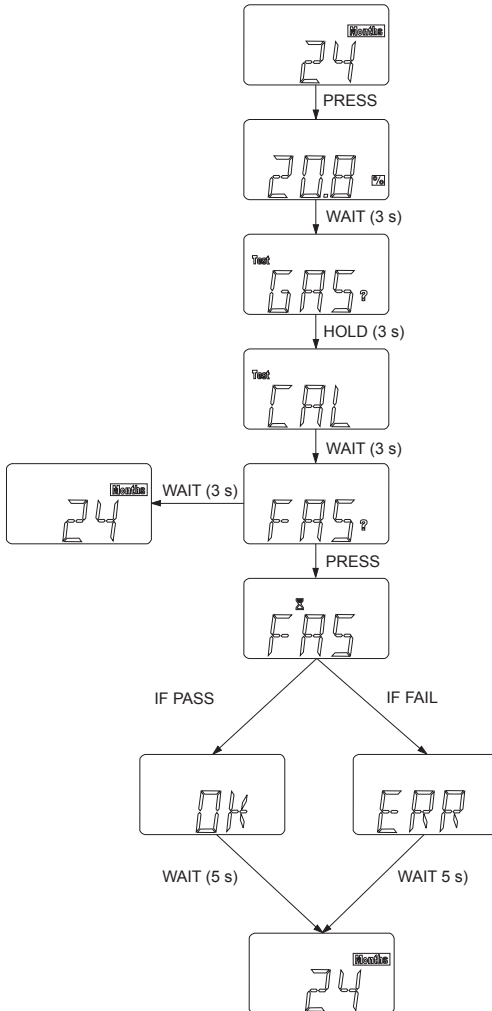



Fig. 9 Calibration – Oxygen

4. Maintenance

The instrument is maintenance-free during its service life.

If irregularities occur during operation, use the displayed error codes to determine how to proceed further.

Troubleshooting

Problem	Description	Reaction
Alternating display		
TMP/ERR	Temperature outside permitted limits	Inform MSA ^{*)}
AD/ERR	No return message from sensor	Inform MSA ^{*)}
EE/ERR	EEPROM error	Inform MSA ^{*)}
MEM/RST	EEPROM Data Error	Calibrate instrument. Reconfigure any custom settings (alarm setpoints, datalog, etc...)
PRG/ERR	Memory error	Inform MSA ^{*)}
RAM/ERR	RAM error	Inform MSA ^{*)}
TMR/ERR	Time or date error	Inform MSA ^{*)}
BTN/ERR	Keys error (sticking)	Inform MSA ^{*)}
PWR/ERR	Power supply error	Inform MSA ^{*)}
LED/ERR	LED error	Check alarm LEDs
VIB/ERR	Vibration alarm error	Check vibration alarm
UNK/ERR	Indefinable error	Inform MSA ^{*)}
	Battery warning (no alarm)	Instrument out of operation
 /ERR	Battery warning (with alarm – flash LEDs, horn)	Instrument out of operation
SNS/ERR	Sensor error	Inform MSA ^{*)}

^{*)} If the error occurs during the warranty period, please contact the MSA customer service. Otherwise, the instrument must be put out of operation.

To maintain 10% sensor accuracy the instrument should be calibrated periodically.

5. Technical specifications/Certifications

5.1. Technical specifications of the ALTAIR

Weight	125 g (instrument with battery and clip)		
Dimensions	86 x 51 x 50 mm (L x B x T) – with fastening clip		
Alarms	Two super bright LEDs with 320° viewing angle and a loud acoustic alarm		
Volume of acoustic alarm	95 dB typical		
Displays	Large display of measured values		
Battery type	3.6 V dry batteries ½ AA (Lithium), not replaceable		
Battery life	Approx. 24 months under normal conditions		
Sensor	Electrochemical		
Measuring range	H ₂ S	CO	O ₂
	0-100 ppm	0-500 ppm	0-25 % Vol.
Factory alarm setpoints ^{*)}		LOW ALARM	HIGH ALARM
	CO	25 ppm	100 ppm
	H ₂ S	10 ppm	15 ppm
	O ₂	19.5%	23.0%
Temperature range	Operation	: - 20°C to +50°C	
	Storage	: 0°C to +40°C	
	Vibration alarm	: to 0°C	
Humidity range	10 - 95% rel. humidity, non-condensing		
Dust and spray protection	IP 67		
Function tested gases	CO, H ₂ S, O ₂		
Warranty	2 years after activation or 18 hours alarm time on commissioning within 6 months after manufacture		

^{*)} When placing an order, you can request different alarm setpoints. The settings can be changed before commissioning with the help of the test button and thereafter, with the FiveStar®Link™ software.

5.2. Test gases table

Instrument version	Test gas - Self-test	Test gas - Calibration
CO	60 ppm	60 ppm
H ₂ S	40 ppm	40 ppm
O ₂	<19% *)	20.8%

*) The self-test can also be conducted where the operator breathes out onto the sensor for about 3 s - 5 s.

5.3. Certifications

European Community

The product ALTAIR complies with the following directives, standards or standardised documents:

Directive 94/9/EC (ATEX) : FTZU 05 ATEX 0250



II 2G EEx ia IIC T4
 -20 °C ≤ Ta ≤ +50 °C
 EN 50 014, EN 50 020

Directive 89/336/EC (EMC) : EN 50 270 Typ 2, EN 61 000-6-3



0080

Other countries

Country

USA



Exia

Class I, Groups A, B, C, D

Ambient temperature: -20°C to +50°C; T4

Canada



Exia

Class I, Groups A, B, C, D

Ambient temperature: -20°C to +50°C; T4

Australia

Ex ia IIC T4

Ambient temperature: -20°C to +50°C

6. Order Information

Description	Part No.
Test gas cylinder, 60 ppm CO	10073231
Test gas cylinder, 300 ppm CO, RP	10029494
Test gas cylinder, 40 ppm H ₂ S, RP	10011727
Pressure reduction valve, 0.25 l/min	478395
Hose, 40 cm (16")	10030325
Fastening-clip, black	10040002
Fastening-clip, stainless steel	10069894
Belt-clip for mobile telephone	10041105
Key belt	10041107
FiveStar [®] Link [™] software with IR port	710946

Notes



Ex-Ox-Tox Gasdetectie
Westerdreef 5V
2152 CS Nieuw-Vennep
Telefoon: 0252 620885
E-mail: info@exoxtox.nl
Website: www.exoxtox.nl